

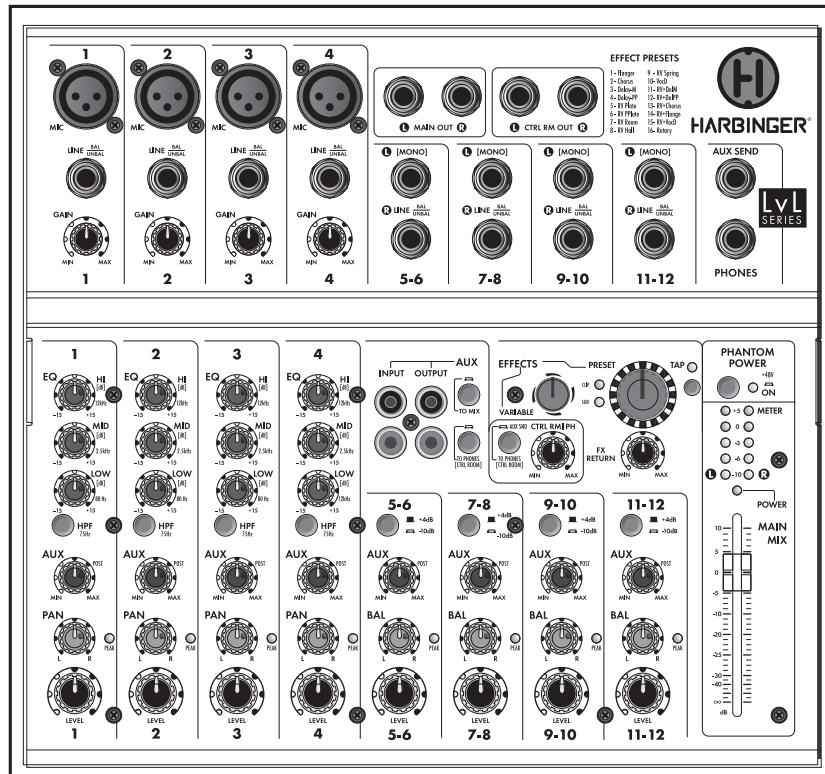

# HARBINGER®



## L1202FX

12-CHANNEL MIXER

**LVL**  
SERIES™

**COMPACT  
MIXER**

# IMPORTANT SAFETY INSTRUCTIONS

Please keep this instruction manual for future reference and for the duration of owning the LvL mixer. Please carefully read and understand the instructions inside this owner's manual before attempting to operate your new powered loudspeaker.

This instruction manual includes essential safety information regarding the use and maintenance of the amplifier. Take special care to heed all warning symbols and signs inside this manual and those printed on the amplifier on the back of the loudspeaker.

## WARNING

TO PREVENT FIRE OR SHOCK HAZARD, DO NOT EXPOSE THE PRODUCT TO WATER/MOISTURE, NOR SHOULD YOU OPERATE THE PRODUCT NEAR ANY WATER SOURCE.

The exclamation point triangular symbol is intended to alert the user to the presence of important operating and maintenance(servicing) instructions in the user manual accompanying the product.

The lightning flash with an arrow triangular symbol is intended to alert the user to the presence of non-insulated "dangerous voltage" within the product's enclosure, and may be of sufficient magnitude to constitute a risk of electric shock.

## WARNING

Handle the power supply cord with care.

Do not damage or deform it as it may cause electric shock or malfunction when used. Hold the plug attachment when removing from wall outlet. Do not pull on the power cord.

## IMPORTANT SAFETY PRECAUTIONS

1. READ INSTRUCTIONS – All the safety and operating instructions should be read before this product is operated.
2. RETAIN INSTRUCTIONS – The safety and operating instructions should be retained for future reference.
3. HEED WARNINGS – All warnings on the product and in the operating instructions should be adhered to.
4. FOLLOW INSTRUCTIONS – All operating and use instructions should be followed.
5. DO NOT turn on the product module before connecting all other external devices.
6. WATER AND MOISTURE – Moisture can damage the product and can cause corrosion of electrical contacts. The system should not be used near water - for example, a bathtub, washbowl, kitchen sink, laundry tub, wet basement, or near a swimming pool, and the like.
7. HEAT – The product should be situated away from heat sources such as radiators, heat registers, stoves, or other sources (including amplifiers) that produce heat.
8. POWER SOURCES – This product should be operated only from the type of power source indicated on the rating label. If you are not sure of the type of power supply to your home, consult your product dealer or local power company.
9. GROUNDING OR POLARIZATION – Do not defeat the safety purpose of the polarization or grounding-type plug. The wide blade or the third prong is provided for your safety. If the provided plug does not fit your outlet, consult an electrician for replacement of the obsolete outlet. Do not defeat the safety purpose of the 3rd pin grounding prong.
10. POWER-CORD PROTECTION – Power supply cords should be routed so that they are not likely to be walked on or pinched by items placed upon or against them, paying particular attention to the cord in correspondence of plugs, convenience receptacles, and the point where they exit from the product.
11. CLEANING – The product should be cleaned only as recommended by the manufacturer. Clean by wiping with a dry cloth. Avoid getting water inside the product.
12. NON-USE PERIODS – The power cord of the product should be unplugged from the outlet when left unused for a long period of time.
13. OBJECT AND LIQUID ENTRY – Care should be taken so that objects do not fall and liquids are not spilled into the enclosure through openings.
14. DAMAGE REQUIRING SERVICE – The product should be serviced by qualified service personnel when:
  - A. The power supply cord or the plug has been damaged; or
  - B. Objects have fallen, or liquid has been spilled into the product; or
  - C. The product has been exposed to rain; or
  - D. The product does not appear to operate normally or exhibits a marked change in performance; or
  - E. The product has been dropped, or the enclosure damaged.
15. Keep the product out of extended or intense direct sun light.
16. No containers filled with any type of liquid should be placed on or near the product.
17. SERVICING – The user should not attempt any service to the product beyond that described in the operating instructions. All other servicing should be referred to qualified service personnel.
18. VENTILATION – Slots and openings in the product are provided for ventilation and to ensure reliable operation of the product and to protect it from overheating. These openings must not be blocked or covered. The openings should never be blocked by placing the product on a bed, sofa, rug, or other similar surface. This product should not be placed in a built-in installation such as a bookcase or rack.
19. ATTACHMENTS – do not use attachments not recommended by the product manufacturer, as they may cause hazards.
20. ACCESSORIES – Do not place this product on an unstable cart, stand, tripod, bracket, or table. The product may fall, causing serious injury to a child or adult, and serious damage to the product. Use only with a cart, stand, tripod, bracket, or table recommended by the manufacturer, or sold with the product.
21. LIGHTNING – For added protection during a lightning storm, or when it is left unattended and unused for long periods of time, unplug it from the wall outlet. This will prevent damage to the product due to lightning and power-line surges.
22. REPLACEMENT PARTS – When replacement parts are required, be sure the service technician has used replacement parts specified by the manufacturer or have the same characteristics as the original part. Unauthorized substitutions may result in fire, electric shock, or other hazards.
23. SAFETY CHECK – Upon completion of any service or repairs to this product, ask the service technician to perform safety checks to determine that the product is in proper operating condition.

To prevent electric shock, do not use a polarized plug with an extension cord, receptacle or other outlet unless the blades can be fully inserted to prevent blade exposure.

	<b>CAUTION</b> RISK OF ELECTRIC SHOCK DO NOT OPEN	<b>AVIS</b> RISQUE DE CHOC ELECTRIQUE NE PAS OUVRIR	
<p><b>CAUTION:</b> To reduce the risk of electric shock, do not remove chassis. No user-serviceable parts inside. Refer servicing to qualified service personnel.</p> <p><b>AVERTISSEMENT:</b> Pour réduire les risques d'incendie et d'électrocution, ne pas exposer ce matériel à la pluie ou à l'humidité.</p>			



THIS SYMBOL IS INTENDED TO ALERT THE USER TO THE PRESENCE OF IMPORTANT OPERATING AND MAINTENANCE (SERVICING) INSTRUCTIONS IN THE LITERATURE ACCOMPANYING THE UNIT.



APPARATUS SHALL NOT BE EXPOSED TO DRIPPING OR SPLASHING AND THAT NO OBJECTS FILLED WITH LIQUIDS, SUCH AS VASES, SHALL BE PLACED ON THE APPARATUS.



# TABLE OF CONTENTS

Quick Start.....	4	Glossary of Terms.....	12
What's on the Front Panel.....	6	Cable Diagrams.....	13
Input Types.....	8	Block Diagram.....	14
Output Types.....	10	Mixer Specifications.....	15
Effects Section.....	11	Warranty/FCC Statements.....	16
Troubleshooting.....	12		

## WELCOME

Congratulations on your recent purchase of a new Harbinger LvL Series mixer. They are the perfect choice for bands or individual musicians who are looking for great-sounding mixes, live performance durability and audio specs that studio users demand.

To get the most out of your new mixer, we suggest that you read through this entire manual at least once, then refer back to it as needed.

# QUICK START

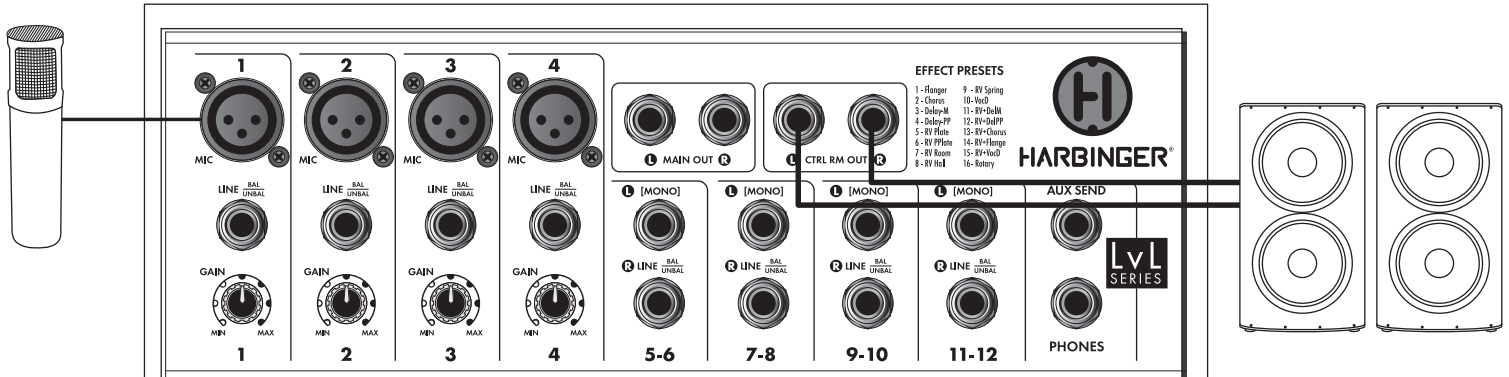

## STUDIO QUICK START – PLUG IN A MICROPHONE AND HEAR IT THROUGH YOUR POWERED STUDIO MONITORS

Before we go through each feature on the mixer, we'll show a few common setups so that you can begin using your mixer right away. In the first example, we're going to connect a microphone and listen to it through powered studio monitors. Be sure to follow the directions so that you don't hear loud feedback through your speakers!

1. Turn the CNTL RM|PH knob (under the effects) all the way down, and the GAIN control on channel 1 (top left) all the way down.
2. Plug your powered studio monitors into the CNTL RM OUT left and right. Switch them on if you need to. (You can also follow this example using headphones.)
3. Turn the LEVEL control on channel 1 up about half way.
4. Plug your microphone into the MIC input on channel 1.
5. If you're using a condenser microphone, switch on the PHANTOM POWER function (top right). If you're using a dynamic mic, or don't know which type you're using, leave phantom power off.
6. Turn the MAIN MIX fader up to 0 (3/4 of the way up).
7. Turn the GAIN control on channel 1 up about 1/2 way. If the PEAK light flashes red, turn the gain back down a bit.
8. Slowly turn up the control room level (CNTL RM|PH) while speaking into the microphone.

You should hear your voice through the speakers. Don't hear anything? Here are a few things to check:

- Are your speakers on? Are their level controls turned up?
- Do you need to switch phantom power on? Look at the markings on your microphone. If it says "condenser" then Phantom Power should be switched on. If it says "dynamic" then leave it off, although phantom power won't damage a dynamic mic.

- Are the level and gain knobs turned up on channel 1? Are the Main Mix and Control Room levels turned up?
- If you only plugged in one speaker, make sure that the PAN control is in the center.
- If the meters above Main Mix are moving, then your problem is with the speakers. If the meters aren't moving, something isn't set correctly on the mixer.

### ADD REVERB

Now that we have signal running through the mixer, let's try out the effects. Picking up where we left off above:

1. Turn the PRESET knob to #5, "RV Plate."
2. Turn up the FX RETURN knob about 1/2 way up.
3. Turn up the AUX control on channel 1 and speak through the microphone. You should see the green light next to the preset knob light up and hear reverb on your voice.
4. Turn the Preset knob to hear the other presets.

### PLAY BACK FROM YOUR COMPUTER OR PORTABLE DEVICE

Next, we're going to play back from a line level device like a computer, smartphone, keyboard, or MP3 player.

1. If still set up as above, turn down the LEVEL control on channel 1. Keep the Main Mix and Control Room levels up.
2. Turn down the Level control for stereo channel 5-6.
3. Plug your computer, smartphone, keyboard, or MP3 player into the LINE INPUT for channels 5 and 6. You'll need 1/4" cables, either balanced or unbalanced will work.
4. Turn up the Level for channels 5-6.

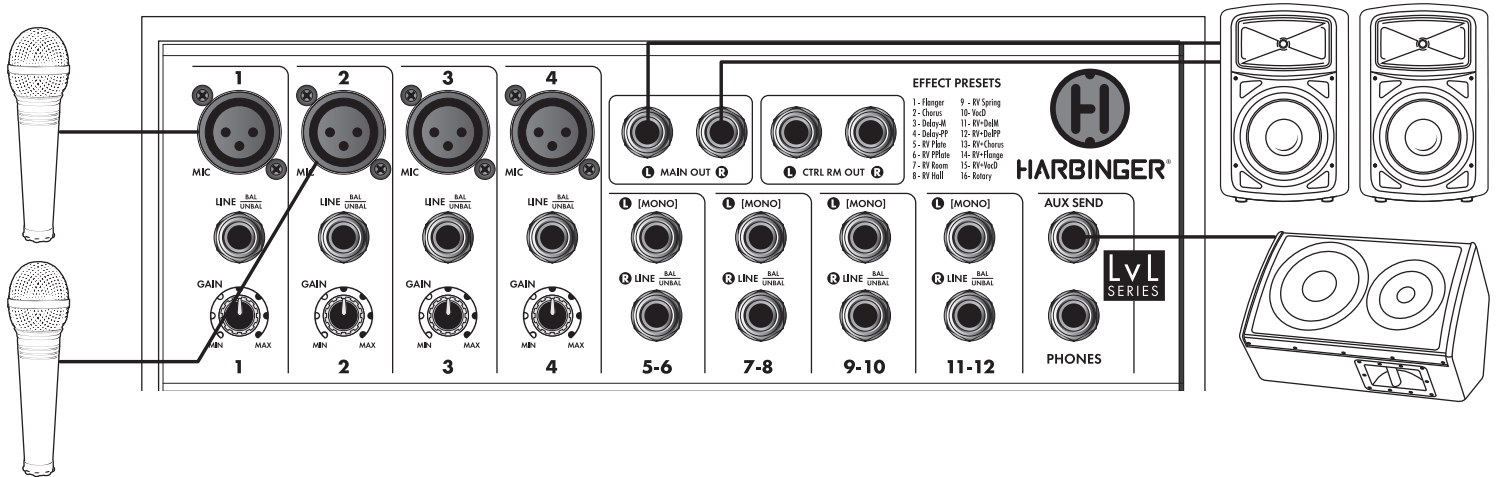

### LIVE SOUND QUICK START – PLUG IN A MICROPHONE AND HEAR IT THROUGH YOUR PA SPEAKERS

Here is a typical live sound setup using two microphones, a stereo PA, and an on-stage floor monitor.

1. Turn the MAIN MIX fader (bottom right) all the way down, and the GAIN control on channels 1 and 2 (top left) all the way down.
2. Plug your speakers into the MAIN OUT left and right. Switch on the power amp.
3. Turn the LEVEL control on channel 1 up about half way.
4. Plug a microphone into the MIC inputs on channels 1 and 2.
5. If you're using a condenser microphone, switch on the PHANTOM POWER function (top right). If you're using a dynamic mic, or don't know which type you're using, leave phantom power off.
6. Turn the MAIN MIX fader up to 0 ( $\frac{3}{4}$  of the way up).
7. Slowly turn the GAIN control on channel 1 up to about  $\frac{1}{2}$  way. Watch the meters above the main fader. If they go up to 0, or if the PEAK light flashes red on your channel, turn the gain back down a bit.
8. Slowly turn up the GAIN on channel 2.
9. Switch on your stage monitor. Turn up the AUX knob on any channel you want to hear on stage.

Remember that the more microphones and speakers you use, the more possibilities there are for feedback.

# WHAT'S ON THE FRONT PANEL

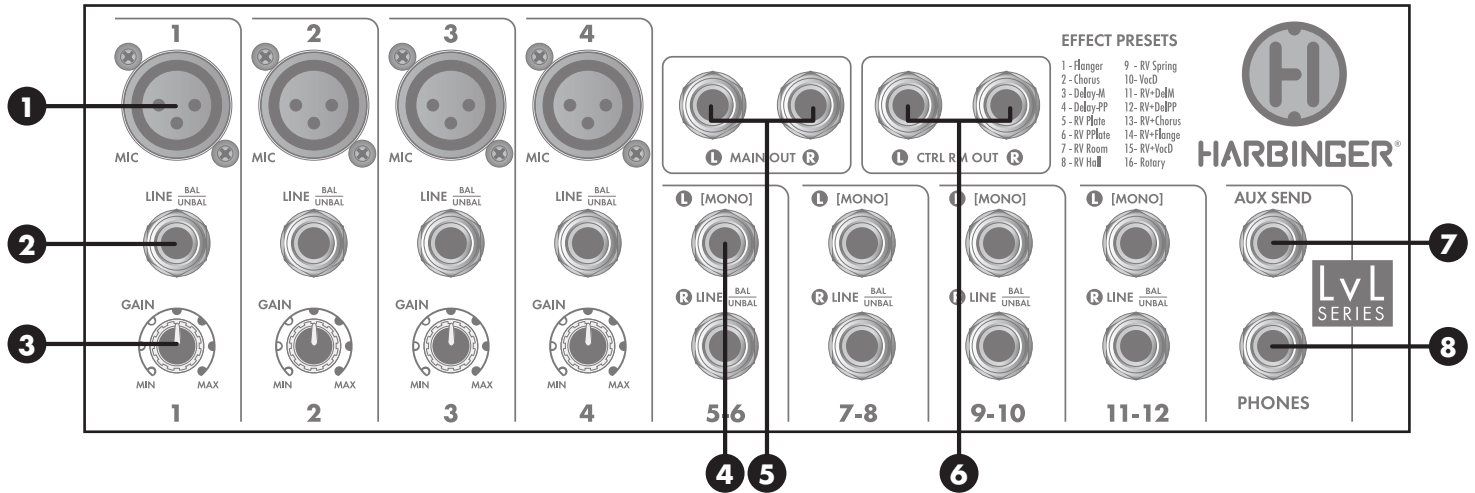

## INPUT/OUTPUT JACKS:

- 1** Mic Input: XLR connector for a microphone-level signal. This input also sends +48V phantom power to a microphone when Phantom Power is switched on.
- 2** Line Input: A 1/4" input that accepts a line-level signal. Either a balanced (TRS) or unbalanced (TS) cable can be plugged in here.
- 3** Gain Control: Controls the input gain for the selected channel, from either the mic or line input.
- 4** Left/Mono Line Input: When this input is used and not the input below, it is sent to both the left and right outputs of the stereo channel. If L and R are both used, a stereo signal is sent to the Main Out.
- 5** Main Out: Outputs controlled by the Main Mix fader.
- 6** Control Room Out: Outputs controlled by the Control Room/Phones knob.
- 7** Aux Send: Output can be connected to a stage monitor or effects processor
- 8** Phones Out: Stereo output for driving a pair of headphones. The output level is controlled by the Control Room/Phones knob.



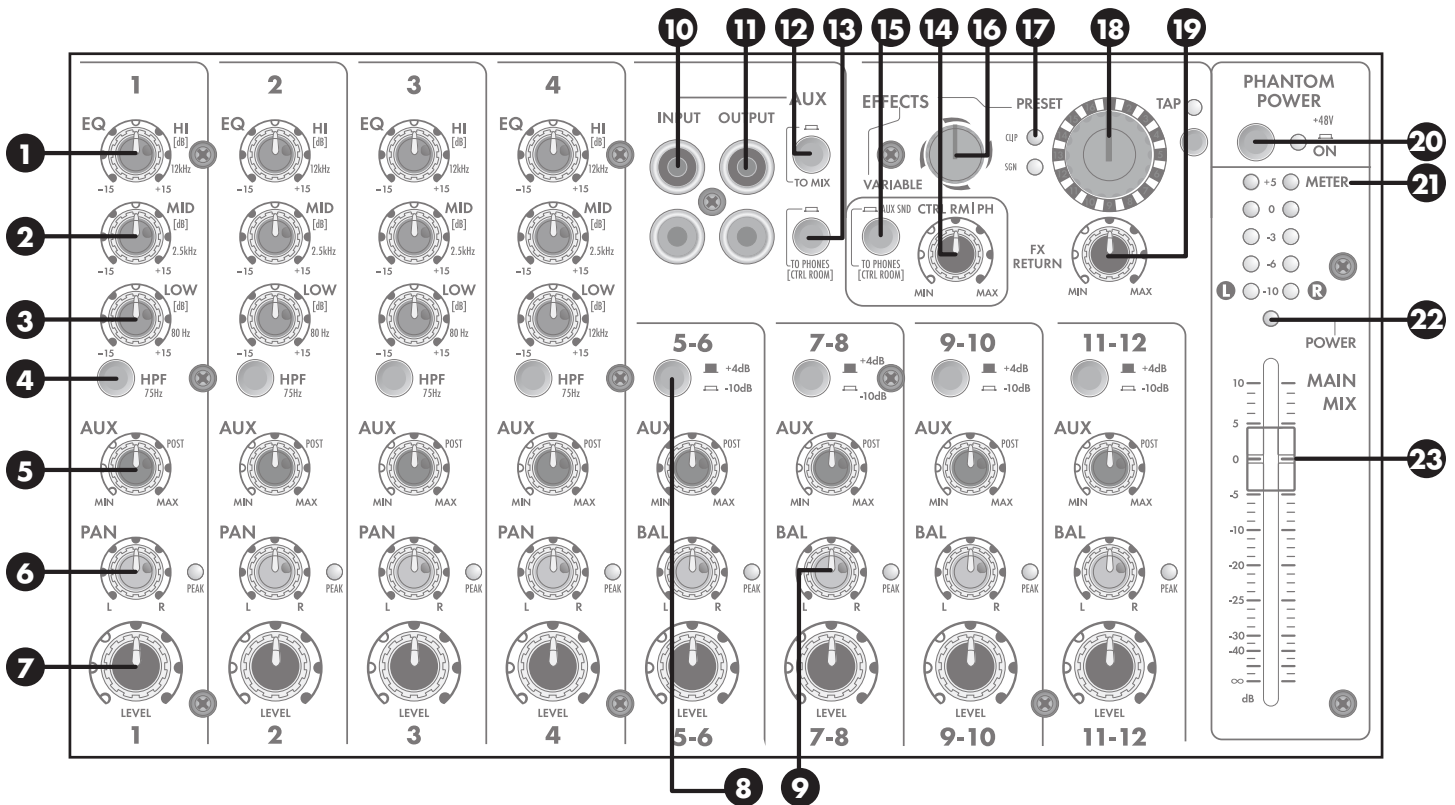

**CONTROL SECTION:**

- 1** High EQ: Controls a high shelving EQ, boosting or cutting frequencies from 12kHz and above
- 2** Mid EQ: A peaking EQ control, boosting or cutting frequencies centered around 2.5kHz
- 3** Low EQ: Controls a low shelving EQ, boosting or cutting frequencies 80Hz and below
- 4** HPF: Cuts all frequencies 75Hz and below
- 5** Aux: A post-fader auxiliary send. It sends the channel to both the built-in effects processor and the Aux Send output.
- 6** Pan: Sends the channel to the left output, right output, or somewhere between.
- 7** Level: Controls the level of the channel going to the Main outputs.
- 8** +4/-10 switch: Changes the input sensitivity. Usually balanced signals be set to +4 and unbalanced connections to -10.
- 9** Balance: Works in a similar way to a pan control, it turns down one side or the other of the stereo input.
- 10** Aux RCA Input: An unbalanced input for a mixdown recorder, MP3 player, computer or other playback source.
- 11** Aux RCA Output: Unbalanced output is useful to send to a recorder, such as a portable recorder or computer to record a live performance.
- 12** To Mix: Sends the Aux RCA Input to the Main outputs for live sound applications.
- 13** To Phones (Control Room): Sends the Aux Input to the headphones and control room outs
- 14** Control Room/Phones level: Controls the level going to the Control Room outputs and the Phones outputs.
- 15** Aux Send to Phones: When pressed, the aux send is sent to the Headphone and Control Room outputs. When up, the Phones and Control Room outputs are the same as the Main Outputs.
- 16** Effects Parameter Variable: Changes the characteristics of the selected effects preset parameters.
- 17** Effects Level/Clip: Displays the level going to the effects processor. When the clip turns on, the effects are being distorted.
- 18** Effects Preset: Changes the effects processor preset, as listed on the top of the mixer.
- 19** FX Return: The overall level from the effects processor that is being sent to the Main outputs
- 20** Phantom Power: Sends 48V phantom power to the XLR inputs.
- 21** Meter: Shows the signal level being sent to the Main Outs. If the red 0 or +5 lights are on, the output is being distorted.
- 22** Power LED: Shows that the mixer is switched on.
- 23** Main Mix: Sets the level to the Main Outs.

# INPUT TYPES

This chapter will review the types of inputs on the L1202FX mixer and explain each of their features.

## CHANNELS 1-4: MIC/LINE INPUTS

### MICROPHONE INPUT (MIC)

This XLR connector will accept virtually any professional microphone. It is designed for microphone level signals. If you have a device that plugs into the wall and has an XLR output (like a mic pre/channel strip, guitar multi-effects processor, computer interface), you should get an XLR-to-¼" TRS cable and plug it into the line input (below).

Some microphones, mostly condenser mics, need phantom power to operate. Switch on phantom power on the right side of the mixer. If you're unsure if your mic needs phantom power, check the instructions or the manufacturer's website for information. Phantom power should not hurt most microphones, except for very old or damaged ribbon microphones.

Use the microphone preamp's gain control (explained below) to bring the microphone up to a high enough level to use with the mixer.

### LINE INPUT (LINE)

This ¼" input is designed for line-level signals. It accepts either balanced (TRS) or unbalanced (TS) cables. The level of this input is also controlled by the gain control, explained below.

Do not use both the microphone and line inputs on the same channel. The mixer will distort and the noise level will go up.

The line input is not designed to accept an instrument-level signal, such as the output from an electric or acoustic guitar or bass. If you want to plug your instrument into the mixer, we suggest a direct box (also called a DI box). Plug your instrument into the direct box, then plug the output of the direct box into the microphone input of the mixer.

### GAIN

Gain controls the level of the microphone or line level signal plugged into the mixer. If the gain is set too low, the output signal will be noisy when you turn it up at the level control. If gain is set too high, it will distort.

For best performance, set the gain while looking at the meters. Turn the Level control so that it's facing straight up. Then turn the gain up until you see the first or second lights on the meters. Don't set it too high – although you might not hear distortion when playing by itself, when all of the channels are playing at that level they may add together and distort the mixer.

Sidebar: "Why are there two volume controls?"

The Gain and Level controls work together to get the best performance out of the mixer. A quiet signal may need more gain than a loud guitar amp going into a sensitive

microphone. Set the gain so that the level on each channel is roughly the same, then use the Level controls to set the balance that you want in your mix.

### EQ HI

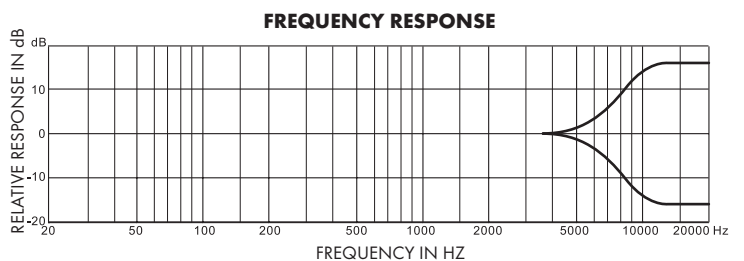

The high EQ control is a shelving EQ. What this means is that it boosts or cuts from 12kHz and everything above that. Turn it up to bring out the breath of a vocal or the high overtones of the cymbals. Turn it down to reduce finger squeaks on a guitar or bass.

### EQ MID

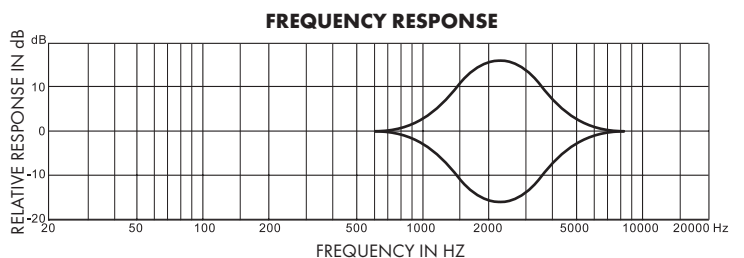

The mid EQ is a peaking EQ, centered at 2.5kHz. This boosts or cuts the high midrange of your signal. You might turn it up if your vocal isn't cutting through the mix, or turn it down if a percussion part is too harsh.



## EQ LOW

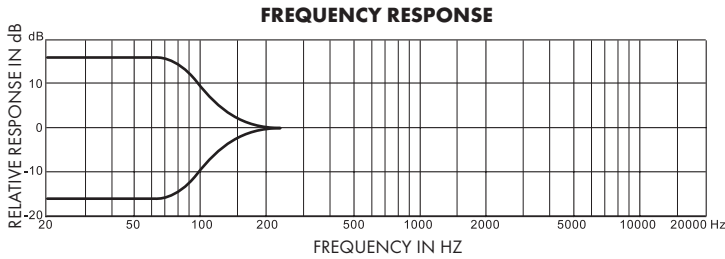

This low EQ boosts or cuts everything from 80Hz or below. You might bring it up for more bottom out of your kick or bass guitar, and turn it down to reduce rumble from a vocal or wind instrument.

## HPF

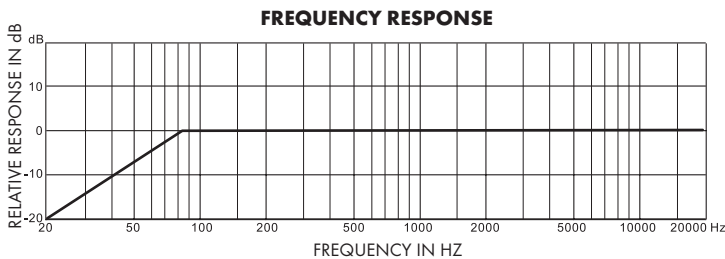

The HPF is a High Pass Filter, centered at 75Hz. This means that it cuts virtually everything below 75Hz. It can be useful for reducing rumble or muddy low tones from an instrument, or as a way to reduce hum in a channel. Try switching on the HPF and boosting the Low EQ for some interesting sounds.

## AUX SEND

The Aux send is separate buss on the L1202FX mixer. This means that you can have a different mix on the aux buss than you do on the main outputs. This comes in handy in a few scenarios:

- Sending different amounts to the effects section, so that some instruments have more reverb than others

- Setting up a headphone mix, so that a recording musician can hear exactly what they want while you listen to your own mix
- Creating a monitor mix on stage, so that band members can hear what they need to perform while you mix for the rest of the club

The L1202FX's aux send is post fader. This means that if the Level is turned all the way down, you can't send anything to the aux buss.

The aux send can be sent to different parts of the mixer, depending on what application you need it for. It always shows up at the Aux Send output of the mixer, and you might plug that into the input of a stage monitor or external effects processor. It also gets sent to the internal effects processor.

Finally, you can send it to the Control Room and headphone outputs by pressing the "Aux Send To Phones" button, next to the Control Room/Phones level control. This allows a musician to hear their own mix while recording with headphones.

If you would like to listen to a different mix through the Control Room than your artist on headphones, you will need to plug the Aux out into a headphone amplifier for the artist while you monitor the main mix.

## PAN

The Pan control moves the signal between the left and right outputs. When turned fully to the left, that channel will only show up on the left main output. When turned to the center, it will be send in equal volume to the left and right outputs. Turned fully to the right, you will only hear it through the right output.

Tip: You can use the pan control to create two mono mixes from the L1202FX. This might be more useful than a stereo mix in a large club, house of worship, conference room, or other special application.

## PEAK

The Peak LED lights up when the level coming into that channel is too loud. If you see this light flash, turn that channel's Gain control down and the Level control up.

## CHANNELS 5-12: STEREO LINE INPUTS

### LEFT/MONO INPUT

This 1/4" input expects a line level signal. It accepts either balanced (TRS) or unbalanced (TS) 1/4" cables. If only the Left/Mono input is used on a channel, that signal will be sent to the left and right outputs. If the Right input is also used, this input will be sent to the left output.

### RIGHT INPUT

As above, this is a line level input, either balanced or unbalanced. It is sent to the right output.

### +4/-10 SWITCH

This switch sets the sensitivity for the channel. It's similar to the gain control, but only has two settings. Generally speaking, if your device has balanced outputs you should use the +4 setting. If your device has unbalanced outputs, use the -10 setting.

The -10 setting actually adds gain to the signal in this case. The number refers to the operating level of the device plugged into the mixer.

### AUX SEND

This sends the channel to the aux buss. See the previous section for more information.

### BALANCE (BAL)

The Balance knob has a similar effect to the pan control explained in the previous section. But the Balance control just turns down one input or the other. As you turn Balance to the right, the signal coming into the Left/Mono input gets softer. This allows you to control the panning in your mix without collapsing the stereo width of the input.

### LEVEL

This controls the level of the channel going to the Main Outs. See the previous section for more information.

### AUX RCA INPUT

The Aux RCA Inputs are a pair of unbalanced RCA phono line inputs. They can be used for a variety of applications:

- Monitoring a mixdown recorder. Since these inputs aren't sent to the Main Outputs, there is no chance of a feedback loop.

- Playing an MP3 player through the PA between band sets
- Sending a signal to the headphone outputs but not to the main outputs. You might plug a set of outputs from a computer interface into these inputs, so that the metronome click can be sent to the headphones but not the main out.

There are two buttons that control where these inputs are heard. One is Aux RCA To Mix and the other is Aux RCA To Phones (Cntl Room.)

When AUX RCA TO MIX is switched on, the Aux RCA input will be heard in the main mix. You might use this to play along with a pre-recorded track, or to play an MP3 player through the PA between band sets as mentioned above.

Pressing AUX RCA TO PHONES/CONTROL ROOM means that the Aux RCA input will be heard through the Control Room and Phones outputs. This is useful if you are recording the mix and want to hear what is coming back from the recorder. This ensures that the recorder is getting the mix that you expect to hear. It also allows you to monitor the recorder output without creating a feedback loop in the speakers.

## OUTPUT TYPES

This chapter explains each of the outputs on the Harbinger L1202FX mixer and their level controls.

### MAIN OUTS

The Main Outs are line outputs. They will work with either balanced or unbalanced cables. The Main Mix fader controls the level of the Main Outputs. You might plug the main outs into a PA amplifier or a mixdown recorder.

All of the channels should show up at the Main outputs. If they don't, make sure that the "Aux RCA to Mix" button isn't pushed.

### CONTROL ROOM OUTPUTS (CNTL RM OUT)

The Control Room Outputs are a separate set of outputs for the mixer to listen to. In a home studio, you might plug these into a set of powered studio monitors. The Cnrl Rm|Ph knob controls the level going to the control room outputs (and the headphones.)

There are three sources that can be sent to the Control Room Outputs. Usually, you listen to the same mix that's coming out of the Main Outs. If the Aux RCA to Phones (Control Room) button is pressed, only the Aux RCA input will be heard through the Control Room outputs.

If the Aux Send to Phones (Cntl Room) is pressed down, the aux send will be heard through the Control Room outputs. This can be useful when preparing a headphone mix for an artist.

### PHONES

This is a headphone-level output. It is designed to drive a pair of headphones with a balanced ¼" connector. If your headphones have a 1/8" stereo jack, you will need an adapter to plug them into the mixer (included with most professional headphones.)

Note that the headphones and the control room outputs are linked – both the mix and level. If you press Aux RCA to Phones (Cntl Rm), the Aux RCA input will be sent to both the control room outs and the headphones. If you turn the control room level all the way down, there will be no signal in the headphones.

### AUX SEND

This jack sends the aux buss out of the mixer. Turn up the Aux knob on any channel to send it to the Aux Send output. See page 9 for more information about the Aux Send.

### AUX RCA OUTPUT

This is a pair of unbalanced line level outputs. They are just a copy of the Main Outputs. If you turn the Main Mix fader down, the level is also reduced here.

# EFFECTS SECTION

The Harbinger L1202FX includes a great-sounding digital effects processor. This chapter explains how to use it.

## PRESET

The L1202FX Effects Processor has 16 presets. Each of these is a different effect type. The preset names are listed on the top of the mixer. They are explained in further detail below.

## VARIABLE PARAMETER

This knob changes the character of the effect depending on the effect type. It either changes the length of a reverb, the feedback/repeat amount of a delay, or the depth of a modulation effect. See the preset descriptions below for more information on how this control works.

## EFFECT PRESET CHART

The chart below describes the presets and what the Variable and Tap controls do for each one.

Preset	Name	Variable Parameter	Tap Control	Description
1	Flanger	Depth, from low to deep	-	Classic stereo flanger with a slow sweep
2	Chorus	Depth, from low to deep	-	Chorus/ensemble effect with short delays
3	Delay-M	Feedback, from single repeat to long repeating echos	Delay Time	Simple mono delay, great for vocals and guitars
4	Delay-PP	Feedback, from single repeat to long echo	Delay Time	Stereo "Ping Pong" delay that jumps from left to right output for complex effects
5	RV Plate	Decay & Brightness - from Short/Bright to Long/Warm	-	Emulation of a '70s plate reverb - a smooth decay for instruments
6	RV PPlate	Decay & Brightness - from Short/Bright to Long/Warm	-	Plate reverb with a short (20ms) pre-delay, perfect for adding space to vocals while keeping them clear and intelligible
7	RV Room	Decay & Brightness - from Short/Bright to Long/Warm	-	Emulates a small studio room, great for adding ambience to drums and instruments
8	RV Hall	Decay & Brightness - from Short/Bright to Long/Warm	-	Gives the sound of a concert hall, ideal for keyboards, string, and wind instruments
9	RV Spring	Decay & Brightness - from Short/Bright to Long/Warm	-	The sound of a spring reverb, adds a funky vintage sound to guitars
10	VocD	Detune amount, light to deep	-	Vocal doubler effect - a Pitch shifter with a slight echo to fatten vocals or guitars
11	Rev+DelM	Reverb decay, short to long	Delay Time	Reverb with a short mono delay
12	Rev+DelPP	Reverb decay, short to long	Delay Time	Reverb with a short stereo ping-pong delay
13	RV+Chorus	Reverb decay, short to long	-	Reverb and chorus multieffect, nice on keyboards
14	RV+Flange	Reverb decay, short to long	-	Reverb and flanger multieffect, interesting with guitar
15	RV+VocD	Reverb decay, short to long	-	Reverb with vocal doubler multieffect, great for pop vocals
16	Rotary	Depth light to deep	-	Emulation of the rotary speaker from an organ, fun for guitars or keyboards

## TAP

On effects presets with delay, press this button twice to set the delay time. This is useful for setting the delay time in tempo with the music. If you want a quarter note delay, press the Tap button on two successive beats of the music and the delay time will jump to that tempo.

## SIGNAL/CLIP LEDS

These show the level going to the input of the effects processor. When you send a channel to the effects processor, using the Aux Send knob, you should see the green Sgn light turn on. If the level gets too high, you'll see the red Clip LED turn on. If this happens, turn down the Aux Send knobs on each channel to avoid distorting the effects.

# TROUBLESHOOTING

In this chapter, we'll discuss common problems and their solutions, as well as who to contact if things go wrong with your mixer.

## TROUBLESHOOTING MATRIX

A microphone is plugged in, but you don't see any level on the main meters.

- Are the Gain and Level knobs turned up?
- Is the Main Mix fader turned up?
- Is the Aux RCA to Mix, Aux RCA to Phones, or Aux to Phones button pressed in?
- If the mic needs phantom power, is the PHANTOM POWER turned on? (Try it if you aren't sure.)
- Try a different microphone cable and/or microphone.
- Check the power connections, your power strip, extension cords, etc.

You can hear everything, but it's very noisy.

- Are all of the level controls turned up very high? Try turning those down and the gain controls up.
- Turn down the FX return. If that was the problem, try sending more signal to the effects by turning all of the Aux knobs up.

- Try turning down channels one at a time. If there is one channel that is contributing most of the noise, try fixing that at the source.

You can see level on the meters, but can't hear anything through the control room speakers.

- Is the Aux to Phones/Control Room or Aux RCA to Phones/Control Room button pressed in?
- Are the monitors switched on?
- If only one output is working, try switching the left and right outputs. If the same channel isn't working, the problem is with the speaker.

You turned up the FX Return knob, but can't hear the effects.

- Are you sending enough level to light the Signal LED next to the preset knob? If not then turn up the Aux knob(s).
- Are you listening to the Aux to Phones/Control Room by mistake?
- Try a different Preset or turn the Variable knob.

# GLOSSARY OF TERMS

## BALANCED

A 3-conductor (including shield), low-impedance connection. Balanced cables are the preferred method for hum-free interconnection of a sound system for their noise-rejection characteristics. (Also see Unbalanced.)

## BUSS

An output destination in a mixer. For example, the left and right main outputs are called busses, because you can send a channel to one or both of them. Also spelled Bus.

## CHANNEL

One of any number of signal paths in an audio circuit, such as input channel, output channel, recording channel, left channel, right channel, etc.

## DECIBEL (DB)

A term representing the ratio between different audio levels. It can either refer to the electrical signal running through a channel or the acoustic sound level coming from a sound source.

## DELAY

Like an echo, this effect duplicates the original signal, then plays it back at a rate you control. The rate at which these repeats occur is the "delay time."

## EQUALIZATION

Electronic filters that adjust the level of certain frequencies. Used for tone enhancement or to reduce extraneous sounds. Two types of EQ shapes are Peak and Shelving, described below.

## IMPEDANCE

Resistance in an electrical circuit measured in Ohms ( $\Omega$ ). Maintaining proper impedance (between amplifier and speakers for example) is important to prevent damage to the amp.

## PEAK EQUALIZER CONTROL

Increase or decrease of a frequency range centered at a specific point, resulting in an EQ curve that looks like a hill (increase) or a valley (decrease). (Compare to Shelving Equalizer Control; see pages 8-9 for more information.)

**PHANTOM POWER**

A voltage signal that runs through a microphone cable to power condenser microphones. Harmless to microphones that don't need it, except for very old and/or damaged ribbon microphones.

**REVERB**

An audio effect that emulates the echo reflections and decay time of a large space.

**SHELVING EQUALIZER CONTROL**

Increase or decrease of all frequencies above or below a specific point. (Compare to Peak Equalizer Control; see pages 8-9 for more information.)

**TRS**

Acronym for Tip-Ring-Sleeve – the three parts of a three-conductor (including shield) audio plug. TRS phone plugs are often used for "balanced" mono connections, or stereo "unbalanced" (head-phone) connections.

**TS**

Acronym for Tip-Sleeve, the two parts of an unbalanced, two-conductor (including shield) phone plug. TS connectors are sometimes called mono or unbalanced plugs or jacks.

**UNBALANCED**

A two-conductor (including shield), high-impedance connection. These are most commonly used for instrument connections and cable runs of less than 20 feet.

**XLR**

The three-pin connector universally used for balanced audio connections. A balanced connection reduces outside noise and interference. (See Balanced above.)

# CABLE DIAGRAMS

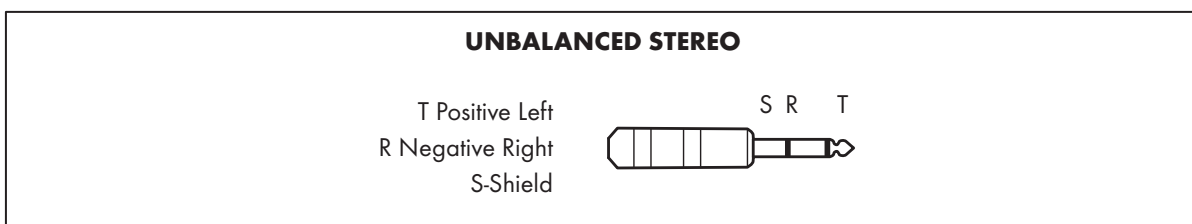
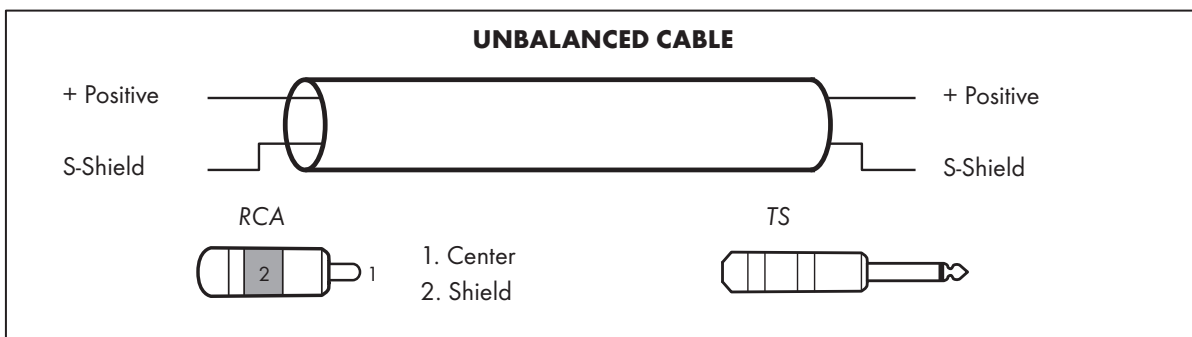
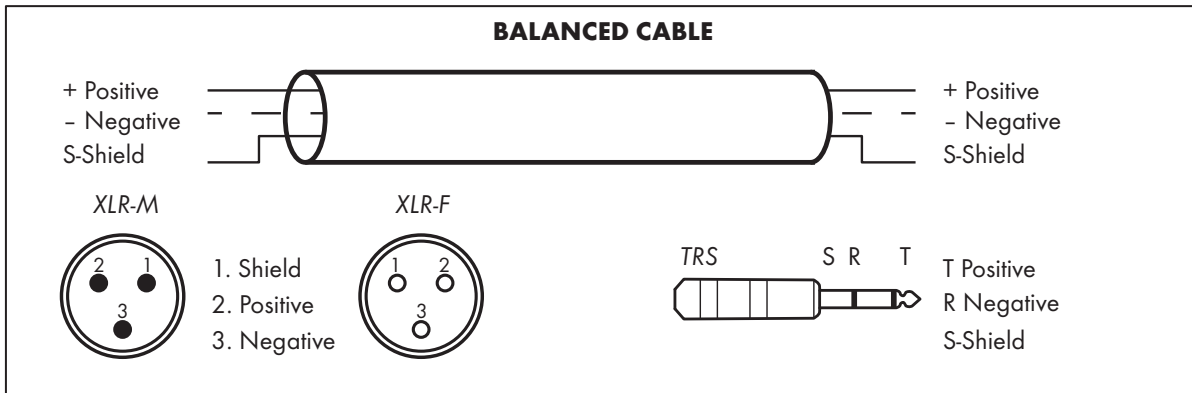

# BLOCK DIAGRAM

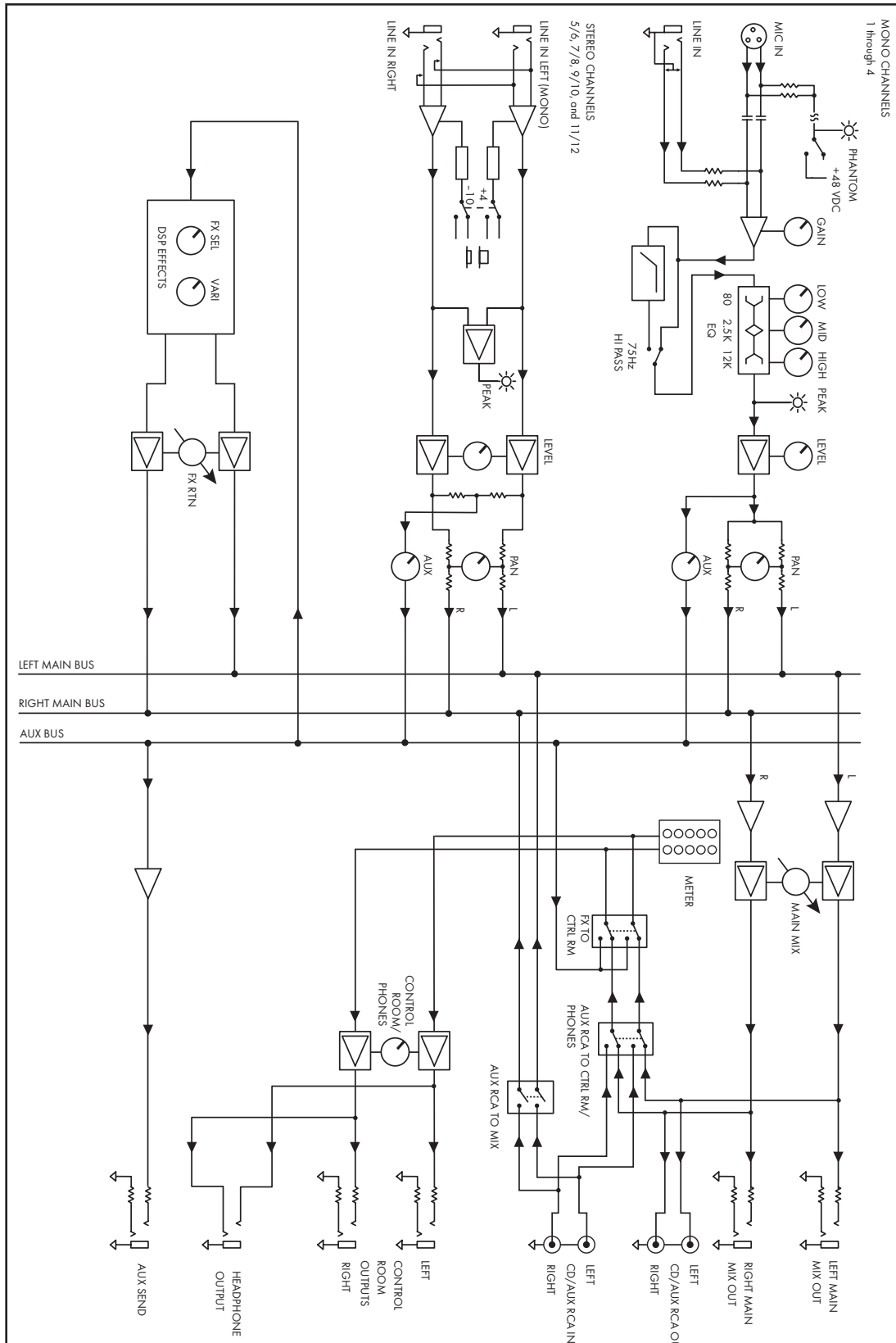



# MIXER SPECIFICATIONS

Parameter	Condition	L502	L802	L1202FX
Frequency response	Mic In to Main Out (Trim at 0 dB):	10Hz - 22kHz +0 -1dB	10Hz - 22kHz +0 -1dB	10Hz - 22kHz +0 -1dB
THD	Mic In to Main Out, 20Hz to 20kHz	0.008%	0.013%	0.007%
Preamp Noise (EIN)	20 Hz to 20 kHz, (150Ω source)	-118 dB	-118 dB	-114 dB
Residual Output Noise	All level controls @ minimum	-87 dB	-88dB	-95dB
Common Mode Rejection Ratio (CMRR)	Maximum Gain	>50dB @ 1kHz	>50dB @ 1kHz	>50dB @ 1kHz
Crosstalk	Adjacent channels	-36dB	-36dB	-36dB
	Same channel (stereo separation)	-88dB	-82dB	-70dB
Input Gain Control Range		0 dB to +50 dB	0 dB to +50 dB	0 dB to +50 dB
Phantom Power	DC	+15V	+48V	+48V
Equalization	Mono Channel, High	±15 dB @ 12 kHz	±15 dB @ 12 kHz	±15 dB @ 12 kHz
	Mono Channel, Mid	n/a	±15 dB @ 2.5 kHz	±15 dB @ 2.5 kHz
	Mono Channel, Low	±15 dB @ 80 Hz	±15 dB @ 80 Hz	±15 dB @ 80 Hz
	Stereo Channel, High	n/a	±15 dB @ 12 kHz	n/a
	Stereo Channel, Mid	n/a	±15 dB @ 2.5 kHz	n/a
	Stereo Channel, Low	n/a	±15 dB @ 80 Hz	n/a
Output Level	Maximum	+20 dBu	+20 dBu	+20 dBu
Maximum Input Levels	Mic	+12 dBu, Gain @ +10 dB	+12 dBu, Gain @ +10 dB	+12 dBu, Gain @ +10 dB
	Line Input	+20 dBu, Gain @ +10 dB	+20 dBu, Gain @ +10 dB	+20 dBu, Gain @ +10 dB
	Aux RCA Input and Aux Return	+20 dBu	+20 dBu	+20 dBu
Input Impedance	Mic Input	2.6 kΩ, balanced	2.6 kΩ, balanced	2.6 kΩ, balanced
	Line Input	20 kΩ, balanced	20 kΩ, balanced	20 kΩ, balanced
	Stereo Aux Returns	20 kΩ, balanced	20 kΩ, balanced	20 kΩ, balanced
	CD/Aux RCA In	24 kΩ, unbalanced	24 kΩ, unbalanced	24 kΩ, unbalanced
Output Impedance	Main	240 Ω, balanced / 120 Ω, unbalanced	240 Ω, balanced / 120 Ω, unbalanced	240 Ω, balanced / 120 Ω, unbalanced
	Ctrl Room, Aux Sends	120 Ω	120 Ω	120 Ω
	Aux RCA Output	1 kΩ	1 kΩ	1 kΩ
	Phones Output	25 Ω	25 Ω	25 Ω
VU Meters	5 Segments	Clip (+18), +6, 0, -20 dB	Clip (+18), +6, 0, -20 dB	Clip (+18), +6, 0, -20 dB
AC Power Requirements	3-pin AC Mini XLR connector	22 VAC _ 2 @ 350mA	22 VAC _ 2 @ 350mA	22 VAC _ 2 @ 350mA
Dimensions	WxDxH (mm)	152x198x60	212x255x60	304x255x60
Weight (net)	without PSU	0.85 kg	1.45 kg	2.10 kg

# WARRANTY

Have a question about service, warranty or parts?

Call **888-286-1809** (Toll Free)

*So we may serve you better, please register on-line at [www.HarbingerProAudio.com](http://www.HarbingerProAudio.com)*

## 2 YEAR HARBINGER LIMITED WARRANTY

Harbinger provides, to the original purchaser, a two (2) year limited warranty on materials and workmanship on all Harbinger cabinets, loudspeaker and amplifier components from the date of purchase.

For warranty support, please visit our website at

**[www.HarbingerProAudio.com](http://www.HarbingerProAudio.com)**, or contact our Support Team at **888-286-1809** for assistance. Harbinger will repair or replace the unit at Harbinger's discretion.

This warranty does not cover service or parts to repair damage caused by neglect, abuse, normal wear and tear and cosmetic appearance to the cabinetry not directly attributed to defects in materials or workmanship. Also excluded from coverage are damages caused directly or indirectly due to any service, repair(s), or modifications of the cabinet, which has not been authorized or approved by Harbinger. This two (2) year warranty does not cover service or parts to repair damage caused by accident, disaster, misuse, abuse, burnt voice-coils, over-powering, negligence, inadequate packing or inadequate shipping procedures.

The sole and exclusive remedy of the foregoing limited warranty shall be limited to the repair or replacement of any defective or non-conforming component. All warranties including, but not limited to, the express

warranty and the implied warranties of merchantability and fitness for a particular purpose are limited to the two (2) year warranty period. Some states do not allow limitation on how long an implied warranty lasts, so the above limitation may not apply to you. There are no express warranties beyond those stated here. In the event that applicable law does not allow the limitation of the duration of the implied warranties to the warranty period, then the duration of the implied warranties shall be limited to as long as is provided by applicable law. No warranties apply after that period.

Retailer and manufacturer shall not be liable for damages based upon inconvenience, loss of use of product, loss of time, interrupted operation or commercial loss or any other incidental or consequential damages including but not limited to lost profits, downtime, goodwill, damage to or replacement of equipment and property, and any costs of recovering, reprogramming, or reproducing any program or data stored in equipment that is used with Harbinger products. This guarantee gives you specific legal rights; you may have other legal rights, which vary from state to state.

Harbinger P.O. Box 5111, Thousand Oaks, CA 91359-5111

All trademarks and registered trademarks mentioned herein are recognized as the property of their respective holders.

## FCC STATEMENTS

1. Caution: Changes or modifications to this unit not expressly approved by the party responsible for compliance could void the user's authority to operate the equipment.
2. Note: This equipment has been tested and found to comply with the limits for a Class B digital device, pursuant to Part 15 of the FCC Rules. These limits are designed to provide reasonable protection against harmful interference in a residential installation. This equipment generate, uses, and can radiate radio frequency energy and, in not installed and used in accordance with the instructions, may cause harmful interference to radio communications. However, there is no guarantee that interference will not occur in a particular installation. If this

equipment does cause harmful interference to radio or television reception, which can be determined by turning the equipment off and on, the user is encouraged to try to correct the interference by one or more of the following measures:

- Reorient or relocate the receiving antenna
- Increase the separation between the equipment and receiver
- Connect the equipment into an outlet on a circuit different from that to which the receiver is connected
- Consult the dealer or an experienced radio/TV technician for help

