

WILLIAMS®

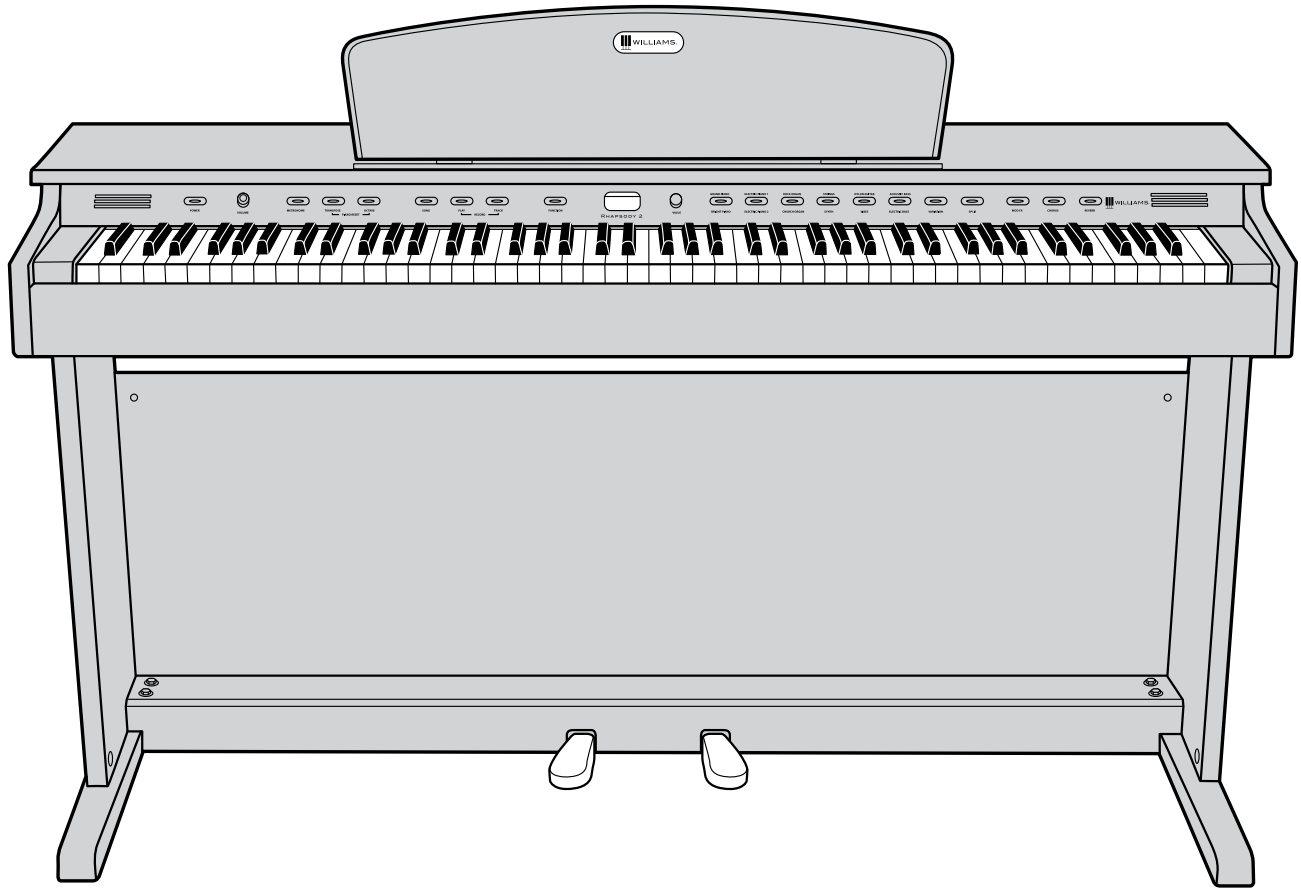

RHAPSODY 2

DIGITAL PIANO

OWNER'S MANUAL

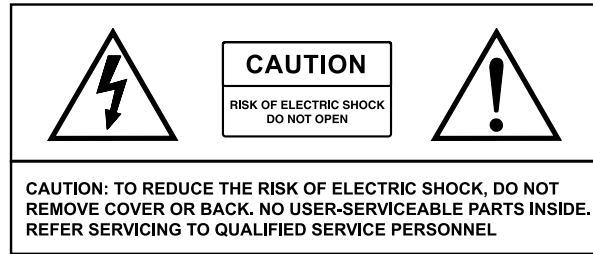

IMPORTANT SAFETY INSTRUCTIONS

- Do not use near water.
- Clean only with a soft, dry cloth.
- Do not block any ventilation openings.
- Do not place near any heat sources such as radiators, heat registers, stoves, or any other apparatus (including amplifiers) that produces heat.
- Do not remove the polarized or grounding-type plug.
- Protect the power cord from being walked on or pinched.
- Only use the included attachments/accessories.
- Unplug this apparatus during lightning storms or when unused for a long period of time.
- Refer all servicing to qualified service personnel. Servicing is required when the apparatus has been damaged in any way, such as power-supply cord or plug is damaged, liquid has been spilled or objects have fallen into the apparatus, the apparatus has been exposed to rain or moisture, does not operate normally, or has been dropped.

FCC STATEMENTS

1. Caution: Changes or modifications to this unit not expressly approved by the party responsible for compliance could void the user's authority to operate the equipment.
2. NOTE: This equipment has been tested and found to comply with a Class B digital device, pursuant to Part 15 of the FCC Rules. These limits are designed to provide reasonable protection against harmful interference in a residential installation. This equipment generates, uses, and can radiate radio frequency energy and, if not installed and used in accordance with the instructions, may cause harmful interference to radio communications. However, there is no guarantee that interference will not occur in a particular installation. If this equipment does cause harmful interference to radio or television reception, which can be determined by turning the equipment off and on, the user is encouraged to try to correct the interference by one or more of the following measures:
 - Reorient or relocate the receiving antenna.
 - Increase the separation between the equipment and receiver.
 - Connect the equipment into an outlet on a circuit different from that to which the receiver is connected.
 - Consult the dealer or an experienced radio/TV technician for help.

RHAPSODY 2 DIGITAL PIANO

ASSEMBLY INSTRUCTIONS

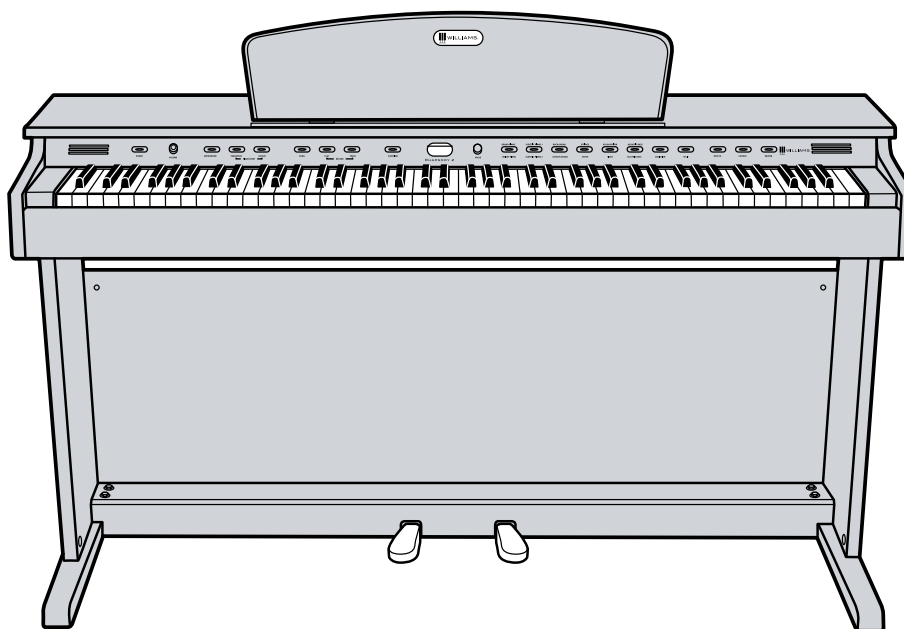

A: M6x20



B: M6x16



C: M4x10



D: M4x16

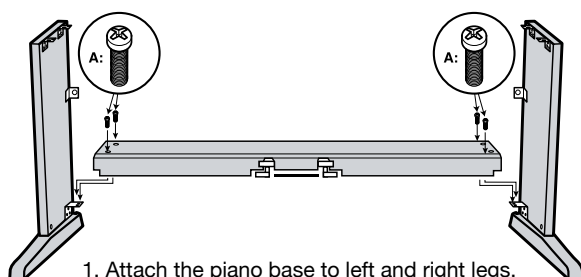

1. Attach the piano base to left and right legs, and secure using four M6x20 screws.

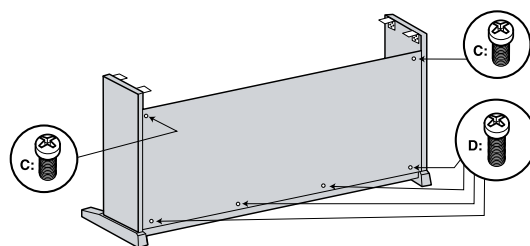

2. Attached the modesty panel to the legs and base, using four M4x16 screws at the bottom of panel. Use two M4x10 screws to secure the top of the modesty panel.

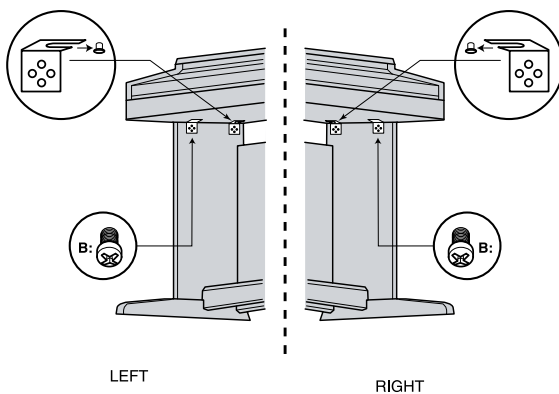

3. Place the main piano section on top of the legs. Slip protruding tabs into slotted brackets in back. Use one M6x16 screw to secure each front bracket.

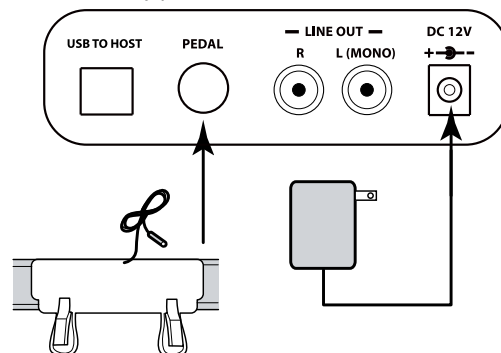

4. Plug in the sustain pedal cable to "Sustain" jack and the power adapter to the "DC 12V" jack.



TABLE OF CONTENTS

IMPORTANT SAFETY INSTRUCTIONS	2	DEMO SONGS.....	10
ASSEMBLY INSTRUCTIONS.....	3	RECORDING	11
INTRODUCTION	4	TUNING.....	12
BEFORE YOU GET STARTED	4	EFFECTS	12 - 14
INITIAL OPERATION / QUICK START	4	MOD FX.....	14 - 16
TAKING CARE OF YOUR DIGITAL PIANO	5	ADVANCED FUNCTIONS	16
TOP PANEL	6-7	MIDI	17 - 18
BACK PANEL	7	SPECIFICATIONS.....	18
BOTTOM PANEL.....	7	MIDI IMPLEMENTATION CHART	19
OPERATIONS	8 - 10	WARRANTY.....	20

INTRODUCTION

Congratulations! You have just purchased a state of the art digital piano that provides remarkable acoustic sound and feel. We recommend that you read through this owner's manual carefully, so you can get the most enjoyment from your new piano.

Features include:

- 88 weighted, velocity-sensitive keys
- 12 piano and keyboard sounds
- Metronome feature with variable tempo to facilitate practice or recording
- USB/MIDI connections and stereo/mono line out jacks

BEFORE YOU GET STARTED

Your piano was carefully packed at the factory, and the packaging was designed to protect the unit from rough handling.

- If the unit is damaged, call Williams Product Support: **(888) 241-1582**
- Use the original packing carton when storing or transporting.
- Make sure children are supervised when near the piano or its packaging.

INITIAL OPERATION / QUICK START

- Plug the power cord into a 110V supply.
- Press the power button. The LED will light.
- Press the Voice Select button for the desired voice.
- Adjust the volume control.

RHAPSODY 2 DIGITAL PIANO

TAKING CARE OF YOUR DIGITAL PIANO

This Williams Rhapsody 2 digital piano will provide years of musical enjoyment if you follow the suggestions listed below.

PRODUCT SERVICING

This product should be serviced by qualified service personnel when:

- The power supply cord or the plug has been damaged.
- Liquid has been spilled into the unit or it has been exposed to rain.
- The instrument does not appear to operate normally or exhibits a marked change in performance.
- The instrument has been dropped or the cabinet has been damaged.
- Please contact support@williams pianos.com for parts and service information.

HANDLING AND TRANSPORT

- Never apply excessive force to the controls, connectors or other parts of the instrument.
- Always unplug cables by gripping the plug firmly, not by pulling on the cable.
- Disconnect all cables before moving the instrument.
- Physical shocks caused by dropping, bumping, or placing heavy objects on the instrument can result in superficial or operational damage.
- Carefully check the volume control before playing. Excessive volume can cause permanent hearing loss.

CLEANING

- Clean the cabinet and panel with a soft, dry cloth. Do not use paint thinner or petrochemical based polishes.
- To maintain the luster of the keys and buttons, wipe with a clean, lightly dampened cloth, and then polish with a soft, dry cloth.

LOCATION

- To avoid deformation, discoloration, or more serious damage, do not expose the instrument to the following conditions: Direct sunlight, high temperatures, excessive humidity, excessive dust, strong vibration.
- Leave enough space around the piano for proper ventilation.
- This instrument contains digital circuitry and may cause or be susceptible to interference if placed too close to radio, television receivers, or mobile phones. If interference occurs, move the instrument further away from the affected equipment.
- Avoid placing vinyl objects on top of the instrument, vinyl can stick to and discolor the surface.

POWER

- Turn the power off when the instrument is not in use.
- To avoid damage to the instrument and other devices to which it is connected, turn the power of all related devices off prior to connection or disconnection of MIDI cables.
- Turn the power off if the main cable is damaged, or the instrument has been exposed to liquid.
- Do not switch the unit on and off in quick succession, as this places an undue load on the electronic components.
- Unplug the AC power adapter during an electrical storm.
- Avoid plugging the AC power adapter into the same AC outlet as appliances with high power consumption, such as electric heaters or ovens



TOP PANEL

LEFT SIDE



Power On/Off

Volume Knob

Controls the overall output volume of the piano.

Metronome

Turns on and off the Metronome.

Transpose

Transposes the key of the piano.

Octave

Transposes the range of the piano keys 1 octave higher or lower.

Piano Reset

Pressing the Transpose and Octave buttons simultaneously will reset the transpose and octave functions to factory settings.

Song

Pressing the Song button and the Voice buttons selects which Demo song will play.

Play

Pressing Play will playback the song you recorded.

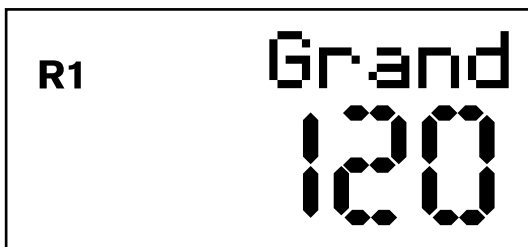

Track / Record

Pressing the Track and Play buttons simultaneously will start the recording function.

Function Button

Selects various functions in the Piano.

LCD Display

Shows the current name of the song or voice as well as the parameter assignments.

Voice Select Buttons

(PIANOS, ELECTRIC PIANOS, ORGANS, BASSES, VIBES, NYLON GUITAR) Pressing these buttons will switch to the sound that is associated with the names printed above them.

Variation Button

This will allow you to switch between the original and variation sounds. When the blue LED is lighted the sound will be the variation sound.

SPLIT Button

Splits the keyboard between right and left side.

Mod FX Button

Turns on and off the Modulation effect assigned to the voice.

Chorus Button

Turns on and off the Chorus effect assigned to the voice.

Reverb Button

Turns on and off the Reverb effect assigned to the voice.

RHAPSODY 2 DIGITAL PIANO

RIGHT SIDE



GRAND PIANO
BRIGHT PIANO

ELECTRIC PIANO 1
ELECTRIC PIANO 2

ROCK ORGAN
CHURCH ORGAN

STRINGS
SYNTH

NYLON GUITAR
VIBES

ACOUSTIC BASS
ELECTRIC BASS

VARIATION

SPLIT

MOD FX

CHORUS

REVERB

BACK PANEL

USB TO HOST



PEDAL

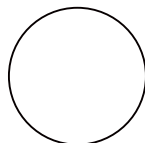

— LINE OUT —

R

L (MONO)

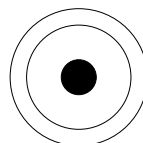
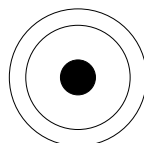

DC 12V

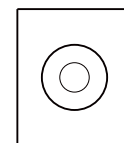

USB Input

The USB connection supports Class Compliant MIDI Drivers to use with MIDI Sequencer applications.

Sustain and Soft Pedal Input

Connects the built-in pedals located at the bottom of the piano.

Outputs-Stereo/ Mono Line Out 1/4" Jacks

The output jacks supply a line-level signal for external amplification. Use both jacks for stereo or just the Left jack for mono.

AC Adapter Input

Connection for the AC power adapter.

Headphones

The headphone jack allows playing in silence. When headphones are plugged in, the speakers are mute. This jack is located on the bottom panel of the piano.



OPERATIONS

The Rhapsody 2 has an LCD that allows you to see the Voice name as well as its parameters.

Most of the front panel buttons are very straight forward and easy to select for general functions. In cases where you want to edit settings in more depth you will need to use the front panel buttons as well as the Function button and Value knob to change parameters.

Powering On the Rhapsody 2

Press the POWER button in the upper left corner of the front panel. This product has a power standby mode. If the piano turns off while you are not playing it, this is likely due to the Power mode being set to Auto Power off. To correct, press the Function Button, then turn the Value Dial to “Auto Power” and set to “Off.”

Metronome Function

Press the Metronome button to turn on the metronome. The LED will light. You will hear the click in headphones or speakers.

Press the Metronome button again to exit metronome function. The LED will turn off.

To Change Metronome Time Signature

1. Press and hold the Metronome button for 2 seconds. The LCD display will show the current metronome signature setting and then go back to current Voice name.
2. Turn the Value Knob to determine the Metro time signature while the display shows the current setting.

The default is 4/4 and the following options are available to toggle through: 2/4, 3/4, 4/4, 5/4, 6/8, 9/8, and 12/8.

You can also change the Metronome time signature with the Function Mode.

1. Press the Function button.
2. Turn the Value Dial to select Metronome signature edit menu. The display will show “Time Sig”.
3. Press the Function button again to enter the relative parameter edit menu, and the parameter will blink to indicate the parameter is editable.
4. Turn the Value Dial to select a time signature.

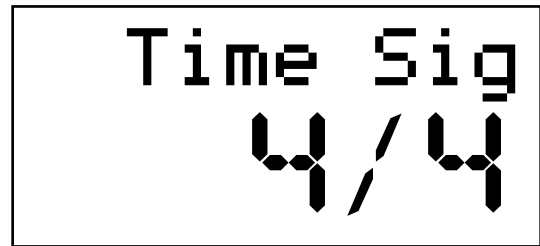

To Set The Volume Level Of The Metronome

1. Press the Function button.
2. Turn the Value Dial to select the Metronome Volume edit menu. The display will show “MetroVol”.
3. Press the Function button again to enter the relative parameter edit menu, and the parameter will blink to indicate the parameter is editable.
4. Turn the Value Dial to select the Metronome Volume range (0-127).

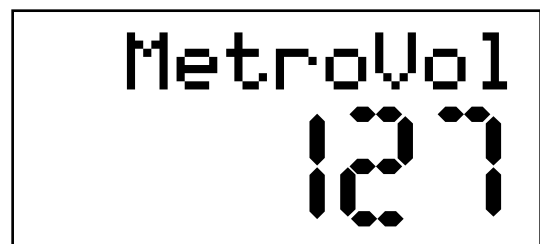

RHAPSODY 2 DIGITAL PIANO

Tempo Setting

5. Press the Function button.
6. Turn the Value Dial to select Tempo edit menu. The display will show "Tempo".
7. Press the Function button again to enter the parameter edit menu. The numeric parameter will blink to indicate the number is editable.
8. Turn the Value Dial to select Tempo (20 - 280).

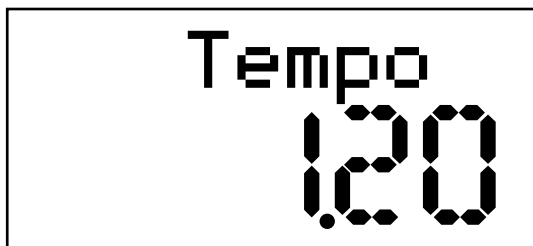

Transpose Function

This function will transpose the piano keyboard by +12 or -12 semitones.

To transpose the keyboard

1. Press the Transpose button. The display will show the current Transpose setting and then change to the current Voice.
2. While the Transpose screen is on you can turn the Value Dial to select the Transpose range (+12 or -12 semitones.)

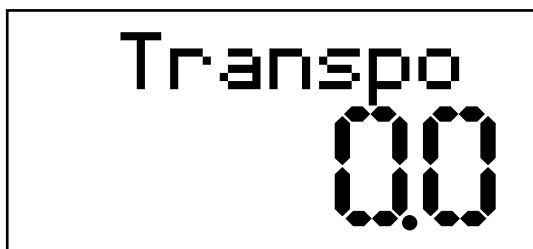

Octave

This function will transpose the piano keyboard up or down up and down by one octave.

There are two kinds of Octaves. One is for full keyboard (right hand) octave the other is for split mode (left hand) octave.

To transpose the full keyboard:

1. Press the Octave button. The display will show the current full keyboard Octave setting ("Main Oct") and then change to the current Voice.
2. While the Octave screen is on you can turn the Value Dial to select the Octave (+ 1 or -1.)

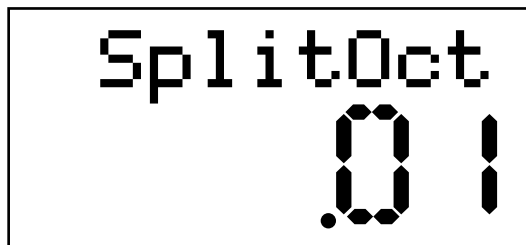

To transpose the split Keyboard, left hand Octave:

1. Press and hold the Octave button, 2 seconds longer the display will show "SplitOct", and then change to the current Voice.
2. While the screen is on showing "SplitOct", turn the Value Dial to select the left hand (split mode) Octave (+1 or -1.)

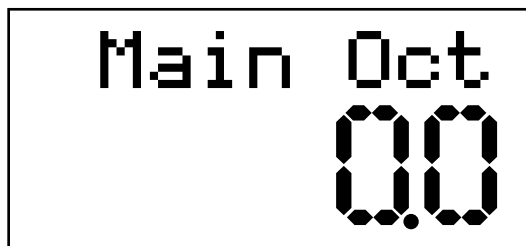

Piano Reset

If you want to quickly reset the keyboard to the normal transposition and Octave ranges you can do so by pressing the Transpose and Octave buttons simultaneously.

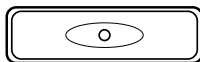

TRANSPOSE

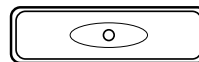

OCTAVE

└─── PIANO RESET ───┘



Voices

The Rhapsody 2 piano has 12 built-in voices. Each voice may be selected one at a time. They can be layered to produce two voices at once, or assigned to the left or right hands in the split mode.

To select a voice, press the Voice Select button of your choice.

The button will light and the LED will indicate the selection as shown below. If the sound is a variation sound the variation light will be on.

DEMO SONGS

The Rhapsody 2 comes with 12 demo songs as well as the ability for you to play and record your own song. When you record your own song the recording will be retained until you either record a new song or if you reset the Rhapsody 2 back to factory settings.

To Play A Demo Song

Press the Song button and the corresponding Voice select button. See list below of the demo songs.

Selecting the Voices

The buttons on the right side of the keyboard in the Voice Select area are for selecting the Sounds or Voices in the Rhapsody 2.

Each Voice has an original and variation version of the sound. Press the Variation button to select the Variation voice.

	Original Voice	Variation Voice
1	Grand Piano	Bright Piano
2	Electric Piano	Electric Piano 2
3	Organ	Organ 2
4	Pad - Strings	Pad - Synth
5	Nylon Guitar	Vibes
6	Acoustic Bass	Electric Bass

Changing the Voice Volume Level

1. Press the Function button.
2. Turn the Value Dial to select Voice Volume Level edit menu, the display will show "M .Volume".
3. Press the Function button again to enter the parameter edit menu. The numeric parameter will blink to indicate the number is editable.
4. Turn the Value Dial to select the level of the voice volume (0-127).

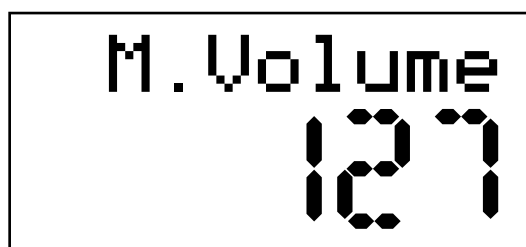

Demo Songs

Piano Song	Voice
1	Grand Piano
2	Electric Piano
3	Organ
4	Strings
5	Nylon Guitar
6	Acoustic Bass
7	Bright Piano
8	Electric Piano 2
9	Cathedral Organ
10	Synth
11	Vibes
12	Electric Bass

RHAPSODY 2 DIGITAL PIANO

RECORDING

Recording Your Own Song

You can record one user song with two tracks in the Rhapsody 2.

1. Press the Track Button and select which track you want to record to with the Value Dial.
2. Press the Play and Track buttons together to start recording. Once you start playing, the display will show a small dot on the screen to indicate that you are waiting to record. Then, when you play the keyboard or press the Play button, the display will show four small dots on the screen to indicate that you are recording.
3. Press the Play and Track buttons together again or press Play only to stop the recorder. Then, press Play only to hear your song.
4. Repeat the steps above to record to the other track.

Layer Mode

To layer two sounds, press the corresponding voices simultaneously. Both voice LEDs will light up to indicate that they are layers.

To layer two sounds from the second bank, simply make sure the variation button is lit and then press the corresponding voices simultaneously.

To layer two sounds in different banks, press and hold simultaneously the instrument in the first bank and the variation button. The variation button LED will blink and the first instrument button will be lit. Once the variation button is blinking, select the layered instrument from the second bank by pressing the corresponding Instrument button. Once selected, this button will blink to indicate that it is from the second bank while the instrument from the first bank stays lit. If one voice is selected from each bank, but they share the same button, the instrument button will blink.

To return to normal, single voice mode, press a single Voice button.

To Change The Layer Volume Level

1. Press the Function button.
2. Turn the Value Dial to select the Layer Volume Level edit menu, the display will show "D .Volume".
3. Press the Function button again to enter parameter edit menu. The numeric parameter will blink to indicate the number is editable.
4. Turn the Value Dial to select the level of the layer volume (0-127).

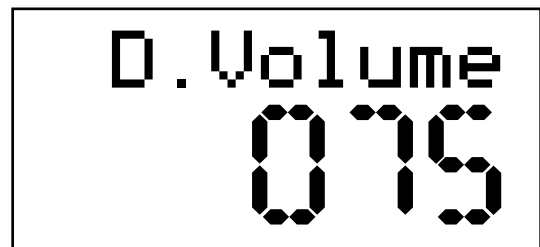

SPLIT MODE

Split Mode allows the keyboard to be divided into two sections so that different voices may be played with the left and right hands. The volume may be independently adjusted for each voice, the Split Point (the highest note played with the left hand) may be adjusted and the Split Voice may be changed as desired.

To Enter Split Mode

Press the [SPLIT] button.

The Split (left hand) voice will be the Acoustic Bass and the last Split Point used.

To Change The Split Volume (Upper And Lower)

1. Press the Function button.
2. Turn the Value Dial to select the Split Volume Level edit menu, the display will show "S .Volume".



3. Press the Function button again to enter the parameter edit menu. The numeric parameter will blink to indicate the number is editable.
4. Turn the Value Dial to select the level of the split volume (0-127).

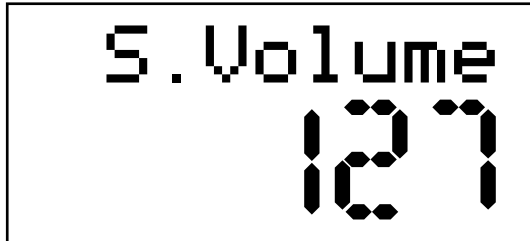

To Change The Split (Left Hand) Voice Note

Press and hold the Split button while depressing the desired Voice Select button.

Change The Main (Right Hand) Voice

1. Press voice buttons will Select the new voice.

To Change the Split Point

Hold the Split button and then press a key on the keyboard to determine the split point.

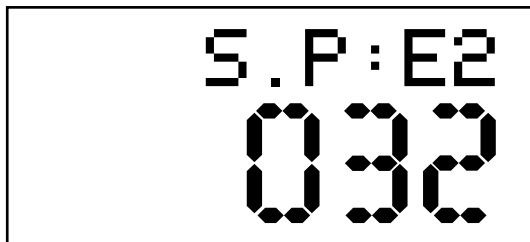

You can also change the split point with the Function Mode.

1. Press the Function button.
2. Turn the Value Dial to select split point edit menu, the display will show "S.P:xx".
3. Press the Function button again to enter the parameter edit menu. The numeric parameter will blink to indicate the number is editable.
4. Turn the Value Dial to select the split point (A-1 to C-7).

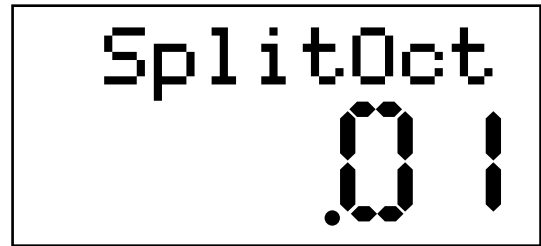

To Change the Split (left hand) Octave

1. Press and hold the [Octave] button, 2 seconds later the LCD will display "Split Oct".
2. When the display is on the split octave screen, turn the Value Dial to change Split Octave (-1 or +1).

To Turn Off Split Mode

Press the Split button. The LED will turn off as well as the currently selected voice.

TUNING

To Change Global Tuning

1. Press the Function button.
2. Turn the Value Dial to select the Tune edit menu. The display will show "Tune a1".
3. Press the Function button again to enter the parameter edit menu. The numeric parameter will blink to indicate the number is editable.
4. Turn the Value Dial to select the Tuning (the range is 415Hz to +466Hz).



EFFECTS

The Reverb and Chorus effects may be applied to each voice individually and will be retained even when the power is turned off.

RHAPSODY 2 DIGITAL PIANO

To apply either effect, press either button. The button will light and the effect will be heard when the piano is played.

To turn off the effect press the button of the desired effect again and the LED light will go off.

Reverb and Chorus settings are set per Instrument and will be retained even when the power is turned off.

Reverb

To change the reverb type:

1. Press the Function button.
2. Turn the Value Dial to select Reverb Type edit menu, the display will show "Rev .Type".
3. Press the Function button again to enter the parameter edit menu. The numeric parameter will blink to indicate the number is editable.
4. Turn the Value Dial to select the Reverb type (OFF and R1 to R8).

Type #	Type Name	Type #	Type Name
R1	Hall1	R5	Room3
R2	Hall2	R6	Stage1
R3	Room1	R7	Stage2
R4	Room2	R8	Plate

To Change Reverb Depth

1. Press and hold the Reverb button, the display will show current depth of the reverb and then return to the current Voice after about 5 seconds.
2. You can turn the Value Dial to select the depth range (0-127.)

You can also change the Reverb depth with the Function button:

1. Press the Function button.
2. Turn the Value Dial to select the Reverb depth edit menu. The display will show "R .Depth".
3. Press the Function button again to enter the parameter edit menu. The numeric parameter will blink to indicate the number is editable.
4. Select the depth range (0-127).

Chorus

Chorus effects add shimmering movement to a voice. The setting can be subtle to extreme.

To Change Chorus Type

1. Press the Function button.
2. Turn the Value Dial to select the Chorus Type edit menu. The display will show "Chr .Type".
3. Press the Function button again to enter the parameter edit menu. The numeric parameter will blink to indicate the number is editable.
4. Turn the Value Dial to select a Chorus Type (OFF and C1 to C8).

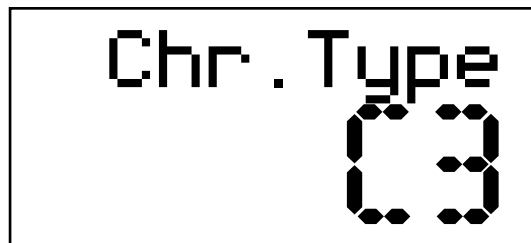

Chorus Type List

Type #	Type Name	Type #	Type Name
C1	Chorus1	C5	Chorus5
C2	Chorus2	C6	Chorus6
C3	Chorus3	C7	Chorus7
C4	Chorus4	C8	Chorus8



To Change Chorus Depth

1. Press and hold the Chorus button, the display will show current depth of the chorus and then return to display current Voice after about 5 sec.
2. While the display shows the Chorus depth, you can turn the Value Dial to select the depth range (0-127.)

Also you can change the Chorus depth with the Function Mode:

1. Press the Function button.
2. Turn the Value Dial to select the Chorus depth edit menu. The display will show “C .Depth”.
3. Press the Function button again to enter the parameter edit menu. The numeric parameter will blink to indicate the number is editable.
4. Select the depth range (0-127).



MOD FX

Modulation effects are designed to add unique playable sound effects to voices.

In addition to the sounds, the Rhapsody 2 has a new effects section that will allow users to have more control over their sounds called Mod FX. These new effects will be inserted into the audio pathway of the sound to the mixer and will be preset into the Patch. When you switch on the specific patch a preset effect will be associated with the sound. You can then select whether the effect should be turned off or modified.

The Mod FX Are:

Bank1	Bank2	Mod FX
Grand	Bright	Tremolo
Electric Piano1	Electric Piano2	Vibrato
Rock Organ	Church Organ	R.Organ: Rotary- Fast/Slow- Change with Church Organ: None
Pad - Strings	Pad - Synth	Tremolo
Nylon Guitar	Vibes	None
Acoustic Bass	Electric Bass	None

To turn on the Mod FX function for an instrument press the ModFx button. The effect will become active and the ModFx LED will light.

To turn off the ModFx, press the button again. The LED on the button will turn off.

Rotary

There is a rotary effect, which is designed for organ voices. To select the speed of the rotary, press the sustain pedal with your foot. Holding down the pedal will speed up the rotary voice to a tremolo. When the pedal is released, the speed of the tremolo will slow down to a choral setting.

Rotary Speed Mode

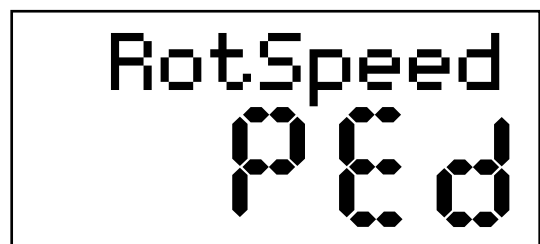

As a default, the Rotary Speed mode is assigned to “PEd”. This mode allows you to change the Rotary Speed by using a foot pedal. Note that the sustain will not hold the sound when your hands are off the keys in this mode.

RHAPSODY 2 DIGITAL PIANO

In "SLW" mode, the speed is assigned to be slow. The sustain pedal will work to sustain the sound.

The last mode is "FST", the speed is assigned to be fast. The sustain pedal will also sustain the sound.

To Change The Rotary Speed Settings In Function Mode

1. Press the Function button.
2. Turn the Value Dial to select the Rotary Speed Mode edit menu, the display will show "RotSpeed".
3. Press the Function button again to enter the parameter edit menu. The numeric parameter will blink to indicate the number is editable.
4. Turn the Value Dial to select the Speed: "PEd(pedal)", "SLW(slow)", "FST(fast)".

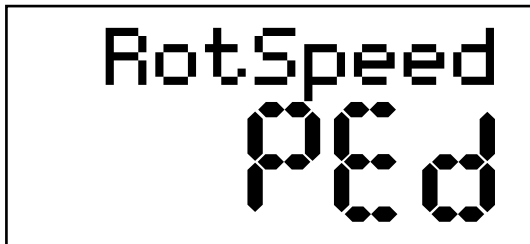

Vibrato

When the Modfx effect is active, the Electric Piano voices will receive the Vibrato effect.



To Change The Vibrato Depth:

1. Press the Function button.
2. Turn the Value Dial to select the Vibrato depth edit menu, the display will show "VibDepth".

3. Press the Function button again to enter the parameter edit menu. The numeric parameter will blink to indicate the number is editable.
4. Turn the Value Dial to select the Vibrato Level (0 - 127).

To Change Vibrato Speed:

1. Press the Function button.
2. Turn the Value Dial to select the Vibrato Depth edit menu, the display will show "VibSpeed".
3. Press the Function button again to enter the parameter edit menu. The numeric parameter will blink to indicate the number is editable.
4. Turn the Value Dial to select the Vibrato Speed (0 - 127).

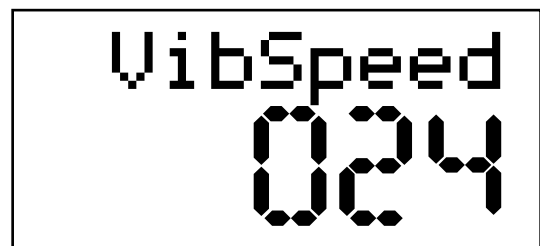

EQ BASS Level Setting

1. Press the Function button.
2. Turn the Value Dial to select the EQ Bass edit menu. The display will show "EQ Bass".
3. Press the Function button again to enter the parameter edit menu. The numeric parameter will blink to indicate the number is editable.
4. Turn the Value Dial to select the EQ Bass Level (-12 to +12).

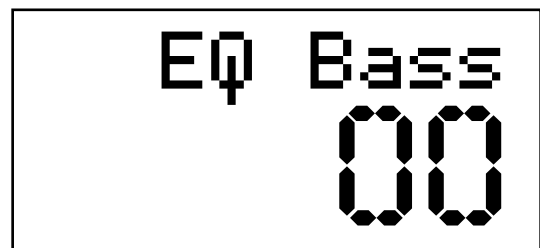

EQ Treble Level Setting

1. Press the Function button.
2. Turn the Value Dial to select the EQ Bass edit menu. The display will show “EQ Treb”.
3. Press the Function button again to enter the parameter edit menu. The numeric parameter will blink to indicate the number is editable.
4. Turn the Value Dial to select the EQ Treble Level (-12 to +12).

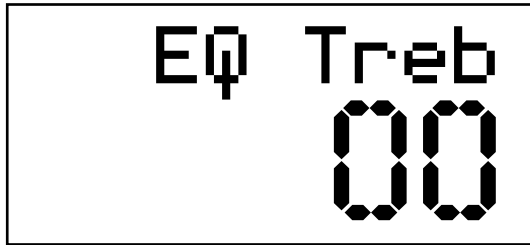

ADVANCED FUNCTIONS

Power Auto Shutting Down On/Off Setting

The Rhapsody 2 has a Power saving function that will shut off the Piano after 30 minutes of non-use. The default setting is Off, however if you find you want this function to work use the steps below.

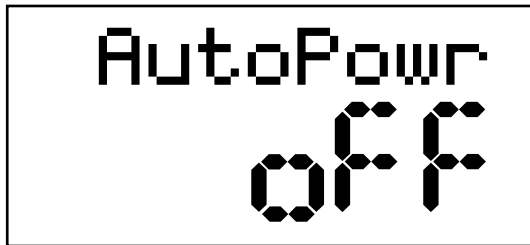

1. Press the Function button.
2. Turn the Value Dial to select the Power Auto edit menu. The display will show “AutoPower”.
3. Press the Function button again to enter the parameter edit menu. The numeric parameter will blink to indicate the number is editable.

4. Turn the Value Dial to select the Power Auto feature on or off.

Factory Reset

Performing a Factory Reset will clear all memory and restore all functions to factory defaults.

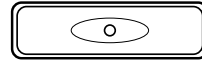

TRANPOSE

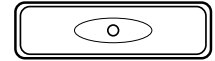

OCTAVE

└── **PIANO RESET** ──┘

1. Turn the Power Off.
2. Press and hold the transpose and octave buttons.
3. Turn the Power on. If the display shows “Reset Ok”, the action is successful.

Touch Sensitivity

You can change the way the keyboard reacts to your playing by adjusting the Velocity curve settings

1. Press the Function button.
2. Turn the Value Dial to select the Velocity Curve edit menu, the display will show “VelCurve”.
3. Press the Function button again to enter the parameter edit menu. The numeric parameter will blink to indicate the number is editable.
4. Turn the Value Dial to select Velocity Curve (1-4).

Velocity Curve List

1. Fixed Velocity
2. Soft
3. Normal
4. Hard

RHAPSODY 2 DIGITAL PIANO

MIDI

The Musical Instrument Digital Interface (MIDI) is an industry-standard protocol that enables electronic musical instruments such as keyboards, computers, drum machines, etc. to communicate, control, and synchronize with each other. MIDI transmissions consist of electronic codes that communicate notes to be played, the instrument, pitch or intensity that notes are to be played with, and controlling codes such as volume, vibrato, cues and clock signals. The Rhapsody 2 has several functions that facilitate its use as a MIDI device or controller.

MIDI Channels

The Rhapsody 2 has 16 channels numbered from 1-16. Each channel is responsible for a voice. When the instrument receives MIDI information from an external device, the active channel is determined by the control message.

The transmission channels are fixed as follows:

Channel 1 Master voice (keyboard)

Channel 2 Split voice (keyboard)

Channel 3 Layer voice (keyboard)

Local On/Off

Turning the Local On/Off function to “Off” will disconnect the keyboard from the internal sound engine of the piano. The Allegro 2 may then be used as a MIDI controller to control other MIDI devices or virtual instrument software running on a computer, without playing the sounds on the piano. Additionally, it may be desirable to turn local playing off for other requirements such as when using MIDI sequencing software on your computer.

Local On/Off Setting

1. Press the Function button.
2. Turn the Value Dial to select the Local on/off edit menu. The display will show “Local”.

3. Press the Function button again to enter the parameter edit menu. The numeric parameter will blink to indicate the number is editable.
4. Turn the Value Dial to select “on” or “off”.



Multitimbral Mode

The Rhapsody 2 is able to receive MIDI information on up to 16 channels simultaneously. If you plan to use your piano with a multitrack MIDI recording system, you can record up to 16 different parts using the Rhapsody 2 voices, each played back individually on different MIDI channels. To ensure your recorded part is played back with the correct voice make sure to press the voice button first and play your part second.

NOTE: Because the Rhapsody 2 is receiving playback information via MIDI, the currently selected voice on the piano may not correspond to the voice being played back.

Setting The Midi Channel

1. Press the Function button.
2. Turn the Value Dial to select the MIDI Channel edit menu. The display will show “MIDI Ch”.
3. Press the Function button again to enter the parameter edit menu. The numeric parameter will blink to indicate the number is editable.
4. Turn the Value Dial to select Midi Channel (1-16).



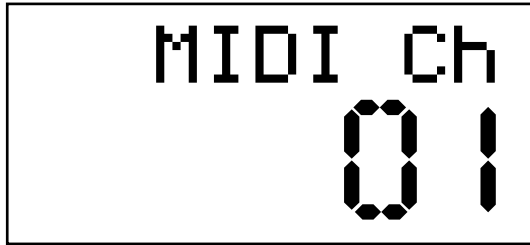

MIDI Panic Reset

If your piano gets a MIDI “Stuck Note”, you can correct it with the following:

1. Press the Function button.
2. Turn the Value Dial to select the Panic menu. The display will show “Panic”.
3. Press the Function button to activate the panic function, then return to Main Voice screen.

Memory Autosave

When modifying the settings of the Williams Rhapsody 2 the following settings will be saved after you turn off the keyboard: Reverb, Chorus (for each voice), Main Volume, Layer Volume, Split Volume, MIDI Channel, Velocity Curve, Power Auto Shutting down ON/OFF, Vibrato Speed, Vibrato Depth, Rotary Speed mode, EQ bass, EQ treble Split Octave, and Split Point.

These settings can be returned to default by performing a factory reset (pg. 16).

SPECIFICATIONS

Keyboard	88 weighted, velocity-sensitive keys
Voices	12
Polyphony	64
Voice Control	Layer, Touch, Split
Pedals	Sustain and Soft Pedals
Demo Songs	12
MIDI Transmit Settings	Local Control
Connectors	USB, DIN connection cable, 2-1/4" (L/R), Phones
Speakers	2-YDT816(4U*15W)
Dimensions	(WxDxH) 54.1" x 16.3" x 31.1"
Weight	83.2 lbs.

RHAPSODY 2 DIGITAL PIANO

MIDI IMPLEMENTATION CHART

Function	Transmitted	Recognized	Remarks
Basic Default Channel Changed	1-16 CH X	1-16 CH 1-16 CH	
Mode Default Messages Altered	Mode 3 X *****	Mode 3 X X	
Note Number: True Voice	0-127 *****	0-127 0-127	
Velocity Note ON Note OFF	O 9nH,v=1-127 O 8nH,v=0	O 9nH,v=1-127 O 9nH,v=0 or 8nh	
After Key's	X	X	
Pitch Bender	X	O	
Control Change 0, 32 1 6 7 10 11 64 66 67 80, 81 84 91, 93 98, 99 100, 101 121	X X X O X X O X O X X X X X O	O O O O O O O O O O O O O O O	Function Modulation Data Entry Volume Pan Expresssion Sustain Sostenuto Soft Pedal DSP Type Portamento DSP Depth NRPN LSB, MSB RPN LSB, MSB Reset All Controllers
Program Change: True	O 0-127 0-127	O 0-127 0-127	
System Exclusive	X	O	
System :Song Position :Song Select Common :Tune	X X O	X X X	
Aux :Local ON/OFF :All Notes OFF Messages :Active Sense :Reset	O O X O	O O X O	

Mode1:OMNI ON, POLY Mode2:OMNI ON,MONO O: Yes
Mode3:OMNI OFF, POLY Mode4:OMNI OFF,MONO X: NO

*1: Registered parameter number:
#0: Pitch sensitivity
#1: Fine tuning in cents
#2: Coarse tuning in half-tones

*2: NRPN 1220h select IFX type
0: off
1: slow rotary
2: fast rotary
3: auto_pan
4: auto_tremelo

NRPN 1230h Enable IFX for current track
NRPN 1237h set global reverb send level if IFX have been enable on this track
NRPN 1238h set global chorus send level if IFX have been enable on this track





WARRANTY

Williams provides the following limited warranty, to the original purchaser: this piano is warranted to be free from electronic and/or structural defects in materials and workmanship for a period of one (1) year from the date of original purchase. If this Williams piano is defective, at its option during the warranty period, subject to the terms of this limited warranty and upon proof of purchase, Williams will either repair or replace the listed piano with a same or similar model of equal age or newer. Any repairs or modifications must be completed by Williams and/or an authorized agent of Williams.

The warranty obligations as set forth herein shall be performed free of charge with the exception of all delivery and shipping expenses. This limited warranty will not apply to this product in the case of misuse, abuse, neglect, alterations, normal wear and tear or other circumstances not directly attributed to electronic and/or structural defects in materials or workmanship. Without limiting the foregoing, this limited warranty will also be inapplicable to products that have not been maintained or replaced in accordance with the manufacturer's instruction, or to products from which the serial number has been removed or altered. If covered defects are found, contact your authorized Williams dealer with regard to the alleged defect within ten (10) days of discovery of the problem.

The foregoing repair or replacement obligation for defective products shall be the sole and exclusive remedy of this limited warranty. All warranties including, but not limited to, the express warranty and the implied warranties of merchantability and fitness for a particular purpose are limited to the one (1) year warranty period. Some states do not allow limitation on how long an implied warranty lasts, so the above limitation may not apply to you. There are no express warranties beyond those stated here. In the event that applicable law does not allow the limitation of the duration of the implied warranties to the warranty period, then the duration of the implied warranties shall be limited to as long as is provided by applicable law. No warranties apply after that period. Retailer and manufacturer shall not be liable for damages based upon inconvenience, loss of use of product, loss of time, interrupted operation or commercial loss or any other incidental or consequential damages including but not limited to lost profits, downtime, goodwill, damage to or replacement of equipment and/or property.

1 Year Parts & Labor Warranty

Register online at www.williamspianos.com

