

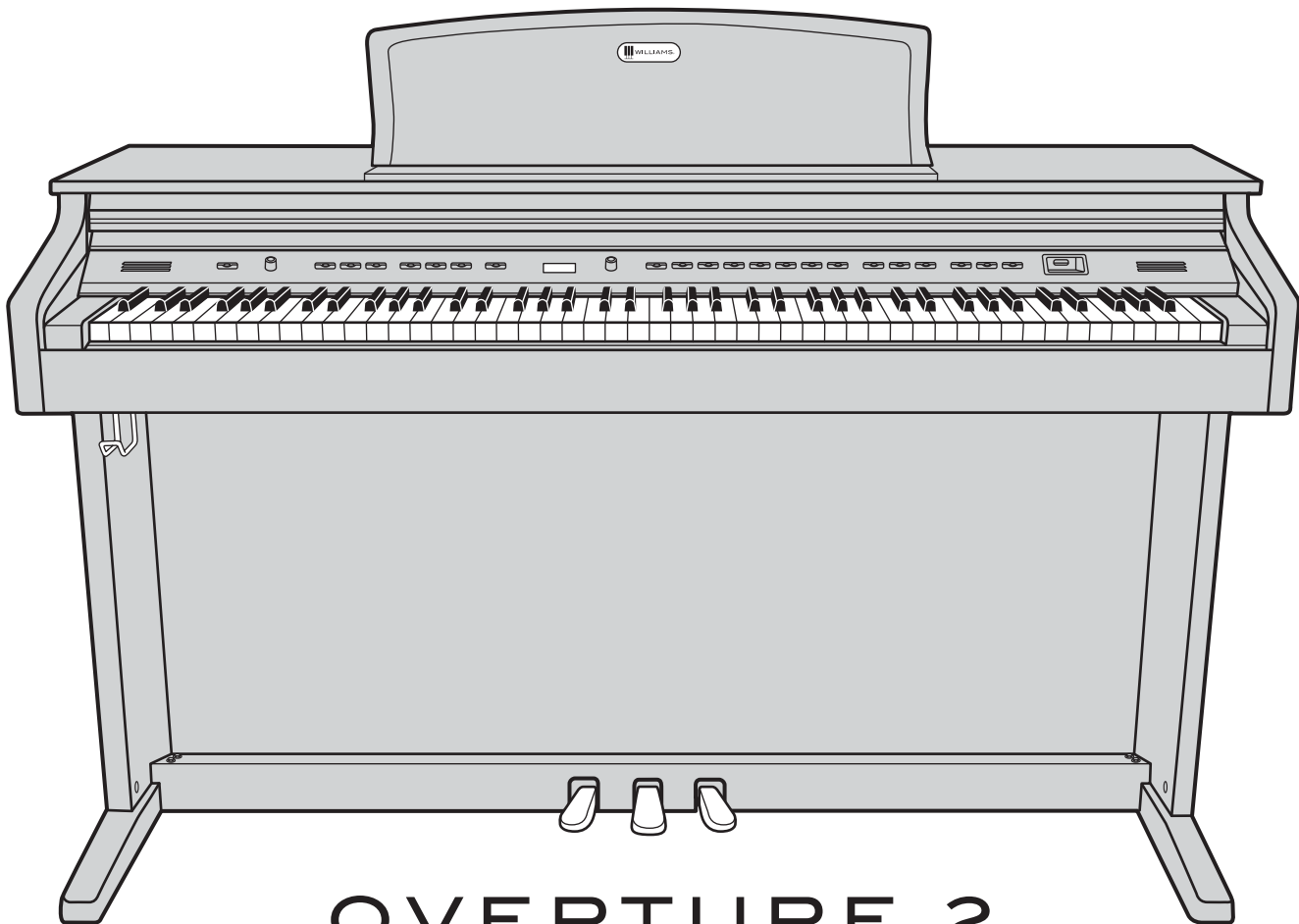

WILLIAMS®



OVERTURE 2

DIGITAL PIANO

OWNER'S MANUAL

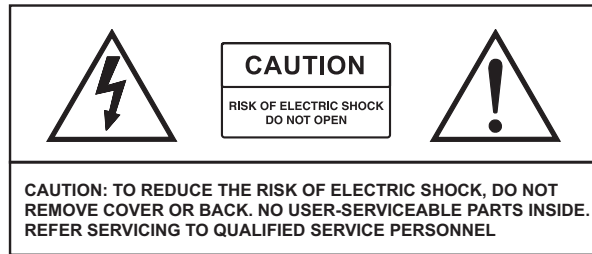

IMPORTANT SAFETY INSTRUCTIONS

- Do not use near water.
- Clean only with a soft, dry cloth.
- Do not block any ventilation openings.
- Do not place near any heat sources such as radiators, heat registers, stoves, or any other apparatus (including amplifiers) that produces heat.
- Do not remove the polarized or grounding-type plug.
- Protect the power cord from being walked on or pinched.
- Only use the included attachments/accessories.
- Unplug this apparatus during lightning storms or when unused for a long period of time.
- Refer all servicing to qualified service personnel. Servicing is required when the apparatus has been damaged in any way, such as power-supply cord or plug is damaged, liquid has been spilled or objects have fallen into the apparatus, the apparatus has been exposed to rain or moisture, does not operate normally, or has been dropped.

FCC STATEMENTS

1. Caution: Changes or modifications to this unit not expressly approved by the party responsible for compliance could void the user's authority to operate the equipment.
2. NOTE: This equipment has been tested and found to comply with a Class B digital device, pursuant to Part 15 of the FCC Rules. These limits are designed to provide reasonable protection against harmful interference in a residential installation. This equipment generates, uses, and can radiate radio frequency energy and, if not installed and used in accordance with the instructions, may cause harmful interference to radio communications. However, there is no guarantee that interference will not occur in a particular installation. If this equipment does cause harmful interference to radio or television reception, which can be determined by turning the equipment off and on, the user is encouraged to try to correct the interference by one or more of the following measures:
 - Reorient or relocate the receiving antenna.
 - Increase the separation between the equipment and receiver.
 - Connect the equipment into an outlet on a circuit different from that to which the receiver is connected.
 - Consult the dealer or an experienced radio/TV technician for help.



OVERTURE 2 DIGITAL PIANO

ASSEMBLY INSTRUCTIONS

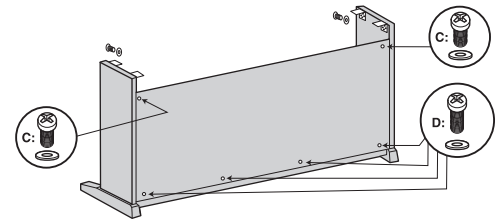
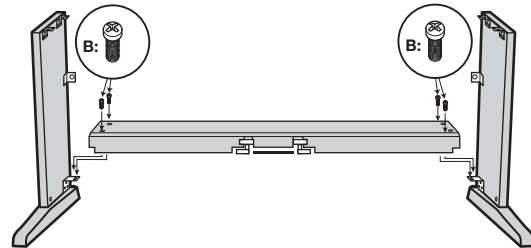
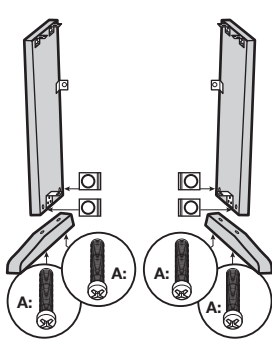
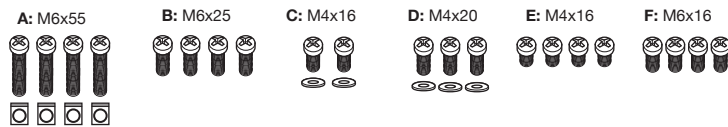
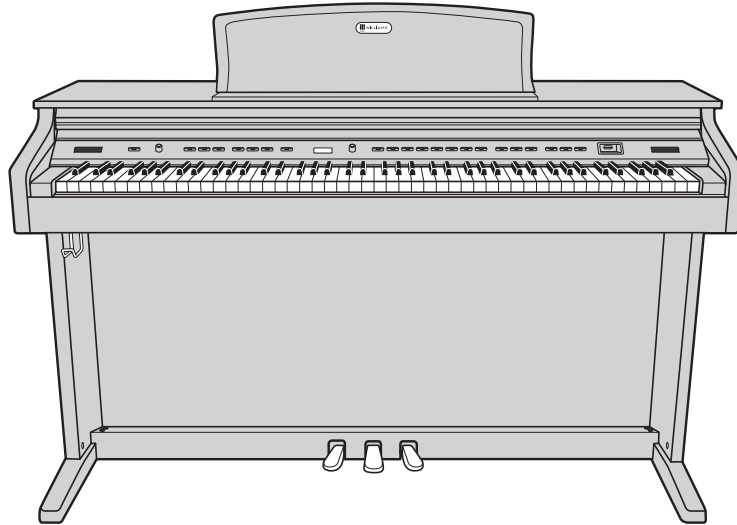

1. Place the four M6x55 screws into the holes in the stand legs, with the philips slot facing out. Use a screwdriver to align the threads in the nuts with the openings on the bottom of the stand legs. Attache the piano base to left and right legs, and secure using four M6x25 screws.

2. Attach the modesty panel to the legs and base, using three M4x20 screws at the bottom of panel. Use two M4x16 screws and washers to secure the top of the modesty panel.

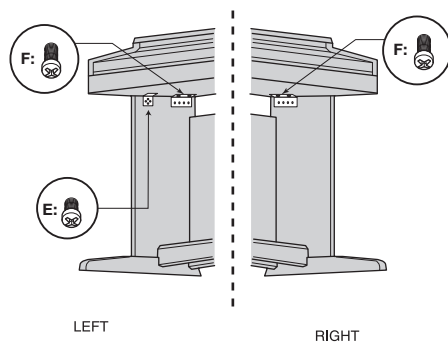

LEFT RIGHT

3. Place the main piano section on top of the legs. Slip protruding tabs into slotted brackets in back. Use two M6x16 screws to secure the left and right bracket. Attach the headphone holder to the bottom left of the piano with four M4x16 screws.

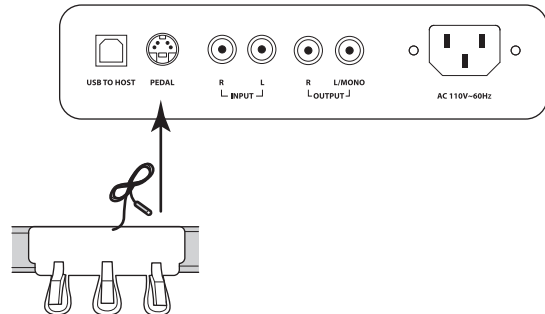

4. Plug in the pedal cable to the pedal jack and the AC power cable to the AC 110V ~ 60Hz jack.





TABLE OF CONTENTS

IMPORTANT SAFETY INSTRUCTIONS	2	MOD FX	14-16
ASSEMBLY INSTRUCTIONS.....	3	ADVANCED FUNCTIONS	16
INTRODUCTION	4	SONG TUTOR.....	17
TAKING CARE OF YOUR DIGITAL PIANO	5	USB SONG MODE	17
TOP PANEL	6	MIDI	18-19
BACK PANEL	7	SPECIFICATIONS.....	20
OPERATIONS	8-10	SOUNDS	21-25
DEMO SONGS.....	10	MIDI NOTES	26-31
RECORDING	10-11	DEMO SONGS FOR THE VOICES	31
SPLIT MODE	12	TUTOR SONGS	32-33
TUNING.....	13	MIDI IMPLEMENTATION CHART.....	34
EFFECTS	13-14	WARRANTY	35

INTRODUCTION

Congratulations! You have just purchased a state of the art digital piano that provides remarkable acoustic sound and feel. We recommend that you read through this owner's manual carefully, so you can get the most enjoyment from your new piano.

Features include:

- 88 weighted, velocity-sensitive keys
- 18 main piano and keyboard direct access sounds and 129 sounds selectable by value dial
- Metronome feature with variable tempo to facilitate practice or recording
- USB/MIDI connections and stereo/mono line out jacks, stereo line input jacks
- USB host device jack

BEFORE YOU GET STARTED

Your piano was carefully packed at the factory, and the packaging was designed to protect the unit from rough handling.

- If the unit is damaged, call Williams Product Support: **(888) 241-1582**.
- Use the original packing carton when storing or transporting.
- Make sure children are supervised when near the piano or its packaging.

INITIAL OPERATION / QUICK START

- Plug the power cord into a 110V supply.
- Press the power button. The LED will light.
- Press the Voice Select button for the desired voice.
- Adjust the volume control.



OVERTURE 2 DIGITAL PIANO

TAKING CARE OF YOUR DIGITAL PIANO

This Williams Overture 2 digital piano will provide years of musical enjoyment if you follow the suggestions listed below.

PRODUCT SERVICING

This product should be serviced by qualified service personnel when:

- The power supply cord or the plug has been damaged.
- Liquid has been spilled into the unit or it has been exposed to rain.
- The instrument does not appear to operate normally or exhibits a marked change in performance.
- The instrument has been dropped or the cabinet has been damaged.
- Please contact support@williams pianos.com for parts and service information.

HANDLING AND TRANSPORT

- Never apply excessive force to the controls, connectors or other parts of the instrument.
- Always unplug cables by gripping the plug firmly, not by pulling on the cable.
- Disconnect all cables before moving the instrument.
- Physical shocks caused by dropping, bumping, or placing heavy objects on the instrument can result in superficial or operational damage.
- Carefully check the volume control before playing. Excessive volume can cause permanent hearing loss.

CLEANING

- Clean the cabinet and panel with a soft, dry cloth. Do not use paint thinner or petrochemical based polishes.
- To maintain the luster of the keys and buttons, wipe with a clean, lightly dampened cloth, and then polish with a soft, dry cloth.

LOCATION

- To avoid deformation, discoloration, or more serious damage, do not expose the instrument to the following conditions: Direct sunlight, high temperatures, excessive humidity, excessive dust, strong vibration.
- Leave enough space around the piano for proper ventilation.
- This instrument contains digital circuitry and may cause or be susceptible to interference if placed too close to radio, television receivers, or mobile phones. If interference occurs, move the instrument further away from the affected equipment.
- Avoid placing vinyl objects on top of the instrument, vinyl can stick to and discolor the surface.

POWER

- Turn the power off when the instrument is not in use.
- To avoid damage to the instrument and other devices to which it is connected, turn the power of all related devices off prior to connection or disconnection of MIDI cables.
- Turn the power off if the main cable is damaged, or the instrument has been exposed to liquid.
- Do not switch the unit on and off in quick succession, as this places an undue load on the electronic components.
- Avoid plugging the AC power cord into the same AC outlet as appliances with high power consumption, such as electric heaters or ovens.



TOP PANEL

LEFT SIDE

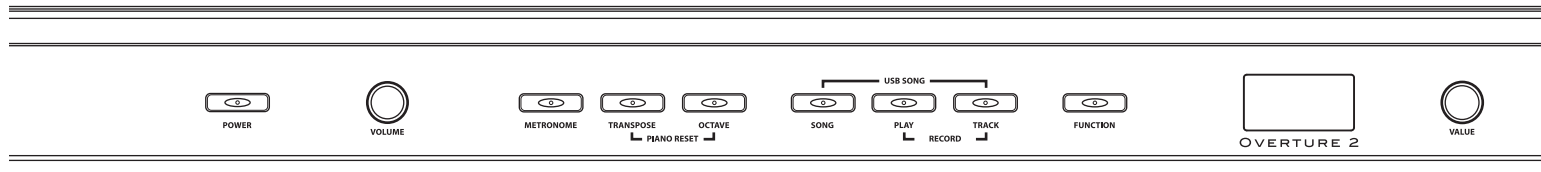

Power On/Off

Volume Knob

Controls the overall output volume of the piano.

Metronome

Turns on and off the Metronome.

Transpose

Transposes the key of the piano.

Octave

Transposes the range of the piano keys 1 octave higher or lower.

Piano Reset

Pressing the Transpose and Octave buttons simultaneously will reset the transpose and octave functions to factory settings.

Song

Pressing the Song button and the Voice buttons selects which Demo song will play.

Play

Pressing Play will playback the song you recorded.



Track / Record

Pressing the Track and Play buttons simultaneously will start the recording function.

Function Button

Selects various functions in the Piano.

LCD Display

Shows the current name of the song or voice as well as the parameter assignments.

Voice Select Buttons/Value Dial

(Pianos, Electric Pianos, Organs, Bases, Keys 1 and 2) Pressing these buttons will switch on the sound that is associated with the names printed above them.

Variation Button

This will allow you to switch between the original and variation sounds. When the blue LED is lighted the sound will be the first variation sound. When the Red LED is lighted it will be the second variation sound.

SPLIT Button

Splits the keyboard between right and left side.

Mod FX Button

Turns on and off the Modulation effect assigned to the voice.

Chorus Button

Turns on and off the Chorus effect assigned to the voice.

Reverb Button

Turns on and off the Reverb effect assigned to the voice.

Duet Button

Sets the keyboard to allow two players to play notes in the same octaves.

Song Tutor Buttons

Song Teaching Mode for the 50 Built-in songs with right and left hand part mutes.

USB Host Slot

To plug in USB thumb drives and play MIDI files on the drive.

OVERTURE 2 DIGITAL PIANO

RIGHT SIDE

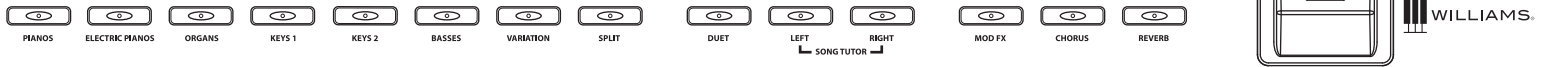

BACK PANEL

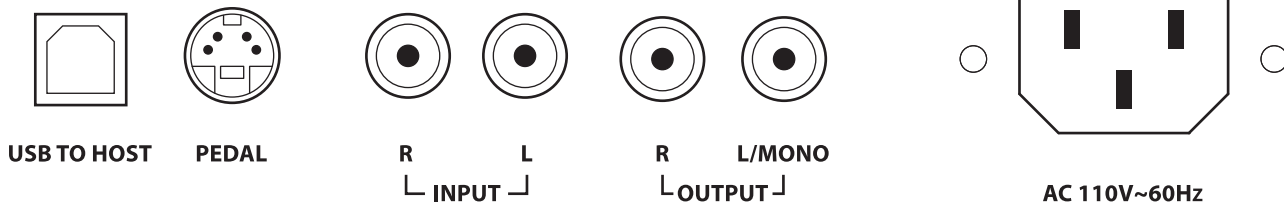

USB Input

The USB connection is to connect the Overture 2 to a computer. The USB connection is Class Compliant so no special USB drivers are needed on your computer.

Sostenuto, Sustain and Soft Pedal Input

Connects the built-in pedals located at the bottom of the piano.

Outputs-Stereo/ Mono Line Out 1/4" Jacks

The output jacks supply a line-level signal for external amplification. Use both jacks for stereo or just the Left jack for mono.

Headphone

The headphone socket disconnects the speakers when headphones are connected.

AC Power Socket

Connection for the AC power.

Inputs- 2 RCA jacks

This allows for audio input from an external audio source such as a MP3 player, computer or tablet computer. The audio input will be mixed with the audio output of the piano.



OPERATIONS

The Overture 2 has an LCD that allows you to see the Voice name as well as its parameters.

Most of the front panel buttons are very straight forward and easy to select for general functions. In cases where you want to edit settings in more depth you will need to use the front panel buttons as well as the Function button and Value knob to change parameters.

Powering On the Overture 2

Press the POWER button in the upper left corner of the front panel. This product has a power standby mode. If the piano turns off while you are not playing it, this is likely due to the Power mode being set to Auto Power off. To correct, press the Function Button, then turn the Value Dial to “Auto Power” and set to “Off.”

Metronome Function

Press the Metronome button to turn on the metronome. The LED will light. You will hear the click in headphones or speakers.

Press the Metronome button again to exit metronome function. The LED will turn off.

To Change Metronome Time Signature

1. Press and hold the Metronome button for 2 seconds. The LCD display will show the current metronome signature setting and then go back to current Voice name.
2. Turn the Value Knob to determine the Metro time signature while the display shows the current setting.

The default is 4/4 and the following options are available to toggle through: 2/4, 3/4, 4/4, 5/4, 6/8, 9/8, and 12/8.

You can also change the Metronome time signature with the Function Mode.

1. Press the Function button.
2. Turn the Value Dial to select Metronome signature edit menu. The display will show “Time Sig”.
3. Press the Function button again to enter the relative parameter edit menu, and the parameter will blink to indicate the parameter is editable.
4. Turn the Value Dial to select a time signature.



To Set The Volume Level Of The Metronome

1. Press the Function button.
2. Turn the Value Dial to select the Metronome Volume edit menu. The display will show “MetroVol”.
3. Press the Function button again to enter the relative parameter edit menu, and the parameter will blink to indicate the parameter is editable.
4. Turn the Value Dial to select the Metronome Volume range (0-127).



Voices

The Overture 2 piano has 18 built-in voices. Each voice may be selected one at a time. Some can be layered to produce two voices at once, or assigned to the left or right hands in the split mode.

To select a voice, press the Voice Select button of your choice.

The button will light and the LED will indicate the selection as shown below. If the sound is a variation sound the variation light will be on.

DEMO SONGS

The Overture 2 comes with 18 demo songs - one for each sound on the front panel - as well as the ability for you to play and record your own song. When you record your own song the recording will be retained until you either record a new song or if you reset the Overture 2 back to factory settings.

To Play A Demo Song

Press the Song button and the corresponding Voice select button. See list below of the demo songs.

Selecting the Voices

The buttons on the right side of the keyboard in the Voice Select area are for selecting the Sounds or Voices in the Overture 2.

Each Voice has an original and 2 variations or a different voice. Press the Variation button to select the Variation voice. There are 3 rows. Row 1 has no LED light. Row 2 has a blue LED light and Row 3 has a Red LED light.

Changing the Voice Volume Level

1. Press the Function button.
2. Turn the Value Dial to select Voice Volume Level edit menu, the display will show "M .Volume".
3. Press the Function button again to enter the parameter edit menu. The numeric parameter will blink to indicate the number is editable.

4. Turn the Value Dial to select the level of the voice volume (0-127).

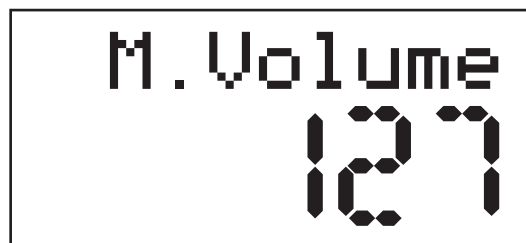

Demo Songs

Piano Song	Voice
1	Grand Piano
2	Electric Piano
3	Organ
4	Nylon Guitar
5	Synth
6	Acoustic Bass
7	Bright Piano
8	Electric Piano 2
9	Cathedral Organ
10	Vibes
11	Strings
12	Electric Bass
13	Layer Piano
14	Electric Piano 3
15	Church Organ
16	Harpsichord
17	Clavinet
18	Synth Bass

RECORDING

Recording Your Own Song

You can record one user song with two tracks in the Overture 2.

1. Press the Track Button and select which track you want to record to with the Value Dial.

OVERTURE 2 DIGITAL PIANO

Front Panel Sound Assignments

Variation Bank						
Original Voice	Grand	EP 1	Perc	Nylon	Synth	Acoustic
	1	2	3	4	5	6
Variation Voice 1	Bright	EP 2	Rock	Vibes	Strings	Fingered
	1	2	3	4	5	6
Variation Voice 2	Layered	EP 3	Church	Harpsichord	Clavinet	Syn BS 1
	1	2	3	4	5	6

2. Press the Play and Track buttons together to start recording. Once you start playing, the display will show a small dot on the screen to indicate that you are waiting to record. Then, when you play the keyboard or press the Play button, the display will show four small dots on the screen to indicate that you are recording.
3. Press the Play and Track buttons together again or press Play only to stop the recorder. Then, press Play only to hear your song.
4. Repeat the steps above to record to the other track.

Layer Mode

To layer two sounds, press the corresponding voices simultaneously. Both voice LEDs will light up to indicate that they are layers.

To layer two sounds from the second bank (third bank), simply make sure the variation button blue LED (red LED) is lit and then press the corresponding voices simultaneously.

To layer sounds from different banks, do the following:

- Press the button of the original voice and the variation button simultaneously.
- Press the Variation button again to cycle through to the desired bank of the layered voice. The Variation button will blink to indicate which bank is selected.

Note: The variation button LED will not blink if the first bank is selected for the layered sound.

- Select the desired voice for the layered sound.

Note: Once selected, the button of the layered voice will blink to indicate that it is from a different bank, while the voice button LED remains lit. The Variation button LED will be lit or unlit to indicate the bank of the original voice.

If one voice is selected from each bank, but they share the same button, the instrument button will blink. If two voices are in the same bank are selected, the buttons should merely light.

To return to normal, single voice mode, press a single Voice button.

To Change The Layer Volume Level

1. Press the Function button.
2. Turn the Value Dial to select the Layer Volume Level edit menu, the display will show "D .Volume".
3. Press the Function button again to enter parameter edit menu. The numeric parameter will blink to indicate the number is editable.
4. Turn the Value Dial to select the level of the layer volume. (0-127)



SPLIT MODE

Split Mode allows the keyboard to be divided into two sections so that different voices may be played with the left and right hands. The volume may be independently adjusted for each voice, the Split Point (the highest note played with the left hand) may be adjusted and the Split Voice may be changed as desired.

To Enter Split Mode

Press the [SPLIT] button.

The Split (left hand) voice will be the Acoustic Bass and the last Split Point used.

To Change The Split Volume (Upper And Lower)

1. Press the Function button.
2. Turn the Value Dial to select the Split Volume Level edit menu, the display will show "S .Volume".
3. Press the Function button again to enter the parameter edit menu. The numeric parameter will blink to indicate the number is editable.
4. Turn the Value Dial to select the level of the split volume. (0-127)



To Change The Split (Left Hand) Voice Note

Press and hold the Split button while depressing the desired Voice Select button or turning the value knob.

Change The Main (Right Hand) Voice

1. Press voice buttons will Select the new voice or turning the value knob.

To Change the Split Point

Hold the Split button and then press a key on the keyboard to determine the split point.



You can also change the split point with the Function Mode.

1. Press the Function button.
2. Turn the Value Dial to select split point edit menu, the display will show "S .P:xx".
3. Press the Function button again to enter the parameter edit menu. The numeric parameter will blink to indicate the number is editable.
4. Turn the Value Dial to select the split point. (A-1 to C-7)



To Change the Split (left hand) Octave

1. Press and hold the [Octave] button, 2 seconds later the LCD will display "Split Oct".
2. When the display is on the split octave screen, turn the Value Dial to change Split Octave. (-1 or +1)

To Turn Off Split Mode

Press the Split button. The LED will turn off as well as the currently selected voice.

Duet Mode

In Duet mode, the keyboard is split into two sections. The left section becomes A2-E6, and

OVERTURE 2 DIGITAL PIANO

the right section becomes F2-C6. The voice of the two sections is the same.

In this mode, the right pedal becomes the sustain pedal for the right section of the keyboard and the left pedal becomes the sustain pedal for the left section of the keyboard. The middle pedal is disabled. This mode is ideal for teacher/student practices.

Press the DUET button and its indicator lights up to show that the DUET mode is engaged. Use the voice buttons or the value dial to select the voice.

Press the DUET button again to exit the duet keyboard mode. The indicator will turn off.

TUNING

To Change Global Tuning

1. Press the Function button.
2. Turn the Value Dial to select the Tune edit menu. The display will show "Tune a1".
3. Press the Function button again to enter the parameter edit menu. The numeric parameter will blink to indicate the number is editable.
4. Turn the Value Dial to select the Tuning. (415Hz to +466Hz)



EFFECTS

The Reverb and Chorus effects may be applied to each voice individually and will be retained even when the power is turned off.

To apply either effect, press either button. The button will light and the effect will be heard when the piano is played.

To turn off the effect press the button of the desired effect again and the LED light will go off.

Reverb and Chorus settings are set per Instrument and will be retained even when the power is turned off.

Reverb

To change the reverb type:

1. Press the Function button.
2. Turn the Value Dial to select Reverb Type edit menu, the display will show "Rev .Type".
3. Press the Function button again to enter the parameter edit menu. The numeric parameter will blink to indicate the number is editable.
4. Turn the Value Dial to select the Reverb type. (OFF and R1 to R8)

Type #	Type Name	Type #	Type Name
R1	Hall1	R5	Room3
R2	Hall2	R6	Stage1
R3	Room1	R7	Stage2
R4	Room2	R8	Plate

To Change Reverb Depth

1. Press and hold the Reverb button, the display will show current depth of the reverb and then return to the current Voice after about 5 seconds.
2. You can turn the Value Dial to select the depth range. (0-127)

You can also change the Reverb depth with the Function button:

1. Press the Function button.
2. Turn the Value Dial to select the Reverb depth edit menu. The display will show "R .Depth".



3. Press the Function button again to enter the parameter edit menu. The numeric parameter will blink to indicate the number is editable.
4. Select the depth range. (0-127)

Chorus

Chorus effects add shimmering movement to a voice. The setting can be subtle to extreme.

To Change Chorus Type

1. Press the Function button.
2. Turn the Value Dial to select the Chorus Type edit menu. The display will show “Chr .Type”.
3. Press the Function button again to enter the parameter edit menu. The numeric parameter will blink to indicate the number is editable.
4. Turn the Value Dial to select a Chorus Type. (OFF and C1 to C8)

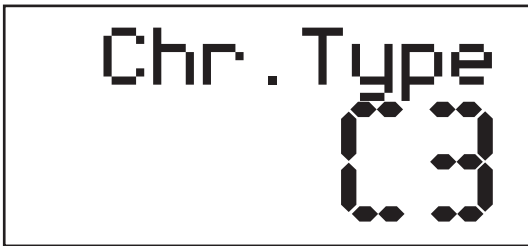

Chorus Type List

Type #	Type Name	Type #	Type Name
C1	Chorus1	C5	Chorus5
C2	Chorus2	C6	Chorus6
C3	Chorus3	C7	Chorus7
C4	Chorus4	C8	Chorus8

To Change Chorus Depth

1. Press and hold the Chorus button, the display will show current depth of the chorus and then return to display current Voice after about 5 sec.

2. While the display shows the Chorus depth, you can turn the Value Dial to select the depth range. (0-127)

Also you can change the Chorus depth with the Function Mode:

1. Press the Function button.
2. Turn the Value Dial to select the Chorus depth edit menu. The display will show “C .Depth”.
3. Press the Function button again to enter the parameter edit menu. The numeric parameter will blink to indicate the number is editable.
4. Select the depth range. (0-127)



MOD FX

Modulation effects are designed to add unique playable sound effects to voices.

In addition to the sounds, the Overture 2 has a new effects section that will allow users to have more control over their sounds called Mod FX. These new effects will be inserted into the audio pathway of the sound to the mixer and will be preset into the Voice. When you switch on the specific voice a preset effect will be associated with the sound. You can then select whether the effect should be turned off or modified.

The Mod FX Are:

Original Grand (Tremolo)	Variation 1 Bright (Tremolo)	Variation 2 Layered (Tremolo)
EPiano1 (Vibrato)	EPiano2 (Vibrato)	EPiano3 (Vibrato)
Perc (Rotary)	Rock (Rotary)	Church (None)
Nylon(Tremolo)	Vibes (None)	Hrpschrd (Tremolo)

OVERTURE 2 DIGITAL PIANO

SynBrss1(Tremolo)	Strings (Tremolo)	Clavinet (Tremolo)
Acoustic (None)	Fingered (None)	Syn BS 1 (None)

To turn on the Mod FX function for an instrument press the ModFx button. The effect will become active and the ModFx LED will light.

To turn off the ModFx, press the button again. The LED on the button will turn off.

Rotary

There is a rotary effect, which is designed for organ voices. To select the speed of the rotary, press the sustain pedal with your foot. Holding down the pedal will speed up the rotary voice to a tremolo. When the pedal is released, the speed of the tremolo will slow down to a choral setting.

Rotary Speed Mode



As a default, the Rotary Speed mode is assigned to "PEd". This mode allows you to change the Rotary Speed by using a foot pedal. Note that the sustain will not hold the sound when your hands are off the keys in this mode.

In "SLW" mode, the speed is assigned to be slow. The sustain pedal will work to sustain the sound.

The last mode is "FST", the speed is assigned to be fast. The sustain pedal will also sustain the sound.

To Change The Rotary Speed Settings In Function Mode

1. Press the Function button.
2. Turn the Value Dial to select the Rotary Speed Mode edit menu, the display will show "RotSpeed".

3. Press the Function button again to enter the parameter edit menu. The numeric parameter will blink to indicate the number is editable.
4. Turn the Value Dial to select the Speed: "PEd(pedal)", "SLW(slow)", "FST(fast)".



Vibrato

When the Modfx effect is active, the Electric Piano voices will receive the Vibrato effect.



To Change The Vibrato Depth:

1. Press the Function button.
2. Turn the Value Dial to select the Vibrato depth edit menu, the display will show "VibDepth".
3. Press the Function button again to enter the parameter edit menu. The numeric parameter will blink to indicate the number is editable.
4. Turn the Value Dial to select the Vibrato Level. (0 - 127)

To Change Vibrato Speed:

1. Press the Function button.
2. Turn the Value Dial to select the Vibrato Depth edit menu, the display will show "VibSpeed".
3. Press the Function button again to enter the



parameter edit menu. The numeric parameter will blink to indicate the number is editable.

- Turn the Value Dial to select the Vibrato Speed. (0 - 127)

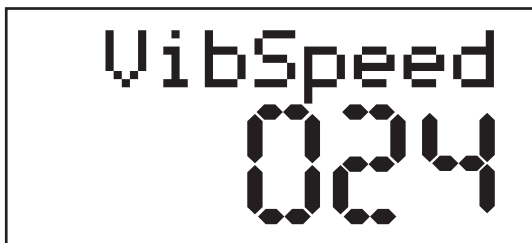

EQ BASS Level Setting

- Press the Function button.
- Turn the Value Dial to select the EQ Bass edit menu. The display will show "EQ Bass".
- Press the Function button again to enter the parameter edit menu. The numeric parameter will blink to indicate the number is editable.
- Turn the Value Dial to select the EQ Bass Level. (-12 to +12)

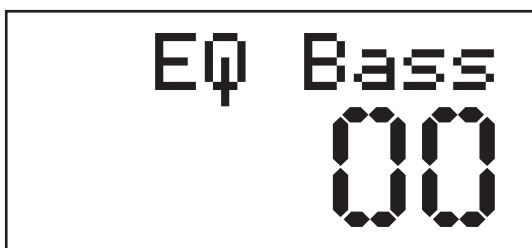

EQ Treble Level Setting

- Press the Function button.
- Turn the Value Dial to select the EQ Bass edit menu. The display will show "EQ Treb".
- Press the Function button again to enter the parameter edit menu. The numeric parameter will blink to indicate the number is editable.
- Turn the Value Dial to select the EQ Treble Level. (-12 to +12)

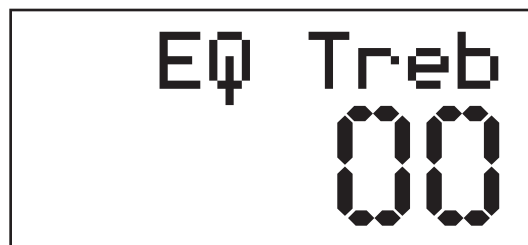

ADVANCED FUNCTIONS

Power Auto Shutting Down On/Off Setting

The Overture 2 has a Power saving function that will shut off the Piano after 30 minutes of non-use. The default setting is Off, however if you find you want this function to work use the steps below.



- Press the Function button.
- Turn the Value Dial to select the Power Auto edit menu. The display will show "AutoPower".
- Press the Function button again to enter the parameter edit menu. The numeric parameter will blink to indicate the number is editable.
- Turn the Value Dial to select the Power Auto feature on or off.

OVERTURE 2 DIGITAL PIANO

Factory Reset

Performing a Factory Reset will clear all memory and restore all functions to factory defaults.



1. Turn the Power Off.
2. Press and hold the transpose and octave buttons.
3. Turn the Power on. If the display shows "Reset Ok", the action is successful.

Touch Sensitivity

You can change the way the keyboard reacts to your playing by adjusting the Velocity curve settings.

1. Press the Function button.
2. Turn the Value Dial to select the Velocity Curve edit menu, the display will show "VelCurve".
3. Press the Function button again to enter the parameter edit menu. The numeric parameter will blink to indicate the number is editable.
4. Turn the Value Dial to select the Velocity Curve. (1-4)

Velocity Curve List

1. Fixed Velocity
2. Soft
3. Normal
4. Hard

SONG TUTOR

The Overture 2 has 50 built-in songs that are designed to help you learn the left and right hand parts separately.

To Play a Song and mute the parts use the steps below.

1. Press both Right and Left buttons to activate the Song Tutor mode. The first song will show up on the display and you will hear a count off measure then the song will play.
2. To change the song turn the Value dial you will see the different names show on the display.
3. To mute the Left or Right hand part press button for the hand you want to mute. The LED on the button will turn off.
4. To unmute the part press the button again.
5. To turn off Song Tutor mode press both buttons again.

To get the sheet music to these songs go to www.williamspianos.com.

USB SONG MODE

The Overture 2 can play standard MIDI files directly from a USB storage drive. USB Drive should use a Windows FAT 32 format to be read by the Overture 2. Also all songs should be on the main directory of the drive. Be sure not to put the MIDI files inside of folders otherwise the Overture 2 will not be able to view the files.

To play MIDI files from the USB Drive.

1. Insert the drive into the HOST USB drive slot. The display will show "Disk In".





2. Press the Song and Track buttons simultaneously. You will then see the first Song name on the drive.
3. To select the song you want to play turn the Value dial.
4. Press the Play button and the song will start. In some cases there will be a count-in on the song (depending on the MIDI file).
5. Press the Play button again to stop the song.

If you remove the drive the display will show “Disk Out” to indicate that the drive has been removed.

MIDI

The Musical Instrument Digital Interface (MIDI) is an industry-standard protocol that enables electronic musical instruments such as keyboards, computers, drum machines, etc. to communicate, control, and synchronize with each other. MIDI transmissions consist of electronic codes that communicate notes to be played, the instrument, pitch or intensity with which notes are to be played, and controlling codes such as volume, vibrato, cues and clock signals. The Overture 2 has several functions that facilitate its use as a MIDI device or controller.

MIDI Channels

The Overture 2 has 16 channels numbered from 1-16. Each channel is responsible for a voice. When the instrument receives MIDI information from an external device, the active channel is determined by the control message.

The transmission channels are fixed as follows:

Channel 1 Master voice (keyboard)

Channel 2 Split voice (keyboard)

Channel 3 Layer voice (keyboard)

Local On/Off

Turning the Local On/Off function to “Off” will disconnect the keyboard from the internal sound engine of the piano. The Overture 2 may then be used as a MIDI controller to control other MIDI devices or virtual instrument software running on a computer, without playing the sounds on the piano. Additionally, it may be desirable to turn local playing off for other requirements such as when using MIDI sequencing software on your computer.

Local On/Off Setting

1. Press the Function button.
2. Turn the Value Dial to select the Local on/off edit menu. The display will show “Local”.
3. Press the Function button again to enter the parameter edit menu. The numeric parameter will blink to indicate the number is editable.
4. Turn the Value Dial to select “on” or “off”.



Multitimbral Mode

The Overture 2 is able to receive MIDI information on up to 16 channels simultaneously. If you plan to use your piano with a multitrack MIDI recording system, you can record up to 16 different parts using the Overture 2 voices, each played back individually on different MIDI channels. To ensure your recorded part is played back with the correct voice make sure to press the voice button first and play your part second.

NOTE: Because the Overture 2 is receiving playback information via MIDI, the currently selected voice on the piano may not correspond to the voice being played back.



OVERTURE 2 DIGITAL PIANO

Setting The Midi Channel

1. Press the Function button.
2. Turn the Value Dial to select the MIDI Channel edit menu. The display will show “MIDI Ch”.
3. Press the Function button again to enter the parameter edit menu. The numeric parameter will blink to indicate the number is editable.
4. Turn the Value Dial to select Midi Channel. (1-16)



MIDI Panic Reset

If your piano gets a MIDI “Stuck Note”, you can correct it with the following:

1. Press the Function button.
2. Turn the Value Dial to select the Panic menu. The display will show “Panic”.
3. Press the Function button to activate the panic function, then return to Main Voice screen.



Memory Autosave

When modifying the settings of the Williams Overture 2 the following settings will be saved after you turn off the keyboard: Reverb, Chorus (for each voice), Main Volume, Layer Volume, Split Volume, MIDI Channel, Velocity Curve, Power Auto Shutting down ON/OFF, Vibrato Speed, Vibrato Depth, Rotary Speed mode, EQ bass, EQ treble Split Octave, and Split Point.

These settings can be returned to default by performing a factory reset. (pg. 16)





SPECIFICATIONS

Keyboard	88 weighted, velocity-sensitive keys
Voices	18 main voices and 129 voices (including GM)
Polyphony	64
Voice Control	Layer, Touch, Split, Metro
Pedals	Sustain, Sostenuto and Soft pedals
Demo Songs	18 demo and 50 Song Tutor songs
MIDI Transmit Settings	Local Control
Connectors	USB, DIN connection cable, 2-1/4" (L/R), 2 aux inputs, Phones
Speakers	4 Total - 2 high and 2 low frequency 10 watts
Dimensions	54.7 x 19.3 x 33.8 inches
Weight	117lbs.
Supplied	Owner's Manual, Music Stand
Optional Accessories	Accessories



OVERTURE 2 DIGITAL PIANO

SOUNDS

Front Panel Sounds

These Voices can be called up from the front panel buttons and the Value Dial.

Front Panel Sound Assignments							
Button	1	2	3	4	5	6	Variation
	Piano	Electric Piano	Organ	Keys 1	Keys 2	Bass	0
	Grand	EP 1	Perc	Nylon	Synth	Acoustic	
	1	2	3	4	5	6	1
	Bright	EP 2	Rock	Vibes	Strings	Fingered	
	1	2	3	4	5	6	2
	Layered	EP 3	Church	Harpsichord	Clavinet	Syn BS 1	
	1	2	3	4	5	6	

All of the Voices in the Overture 2 can be accessed with the front panel Value knob.

Order On Screen	Program Change #	Display Name	
1	0	Grand	Keyboard
2	1	Bright	Keyboard
3	2	Rock Pno	Keyboard
4	3	HonkyTnk	Keyboard
5	2/109*	Layered	Keyboard
6	4	EPiano 1	Keyboard
7	5	EPiano 2	Keyboard
8	5/109*	EPiano 3	Keyboard
9	6	Hrpschrd	Keyboard
10	7/109*	Clav Wah	Keyboard
11	7	Clavinet	Keyboard
12	18/111*	Smiley	Keyboard
13	18/112*	Funky B	Keyboard
14	18/113*	Top&Btm	Keyboard
15	16	Drawbar	Keyboard
16	17	Perc	Keyboard
17	18	Rock	Keyboard
18	18/109*	60s Rock	Keyboard



19	18/110*	OD Rock	Keyboard
20	19	Church	Keyboard
21	20	Reed	Keyboard
22	21	Accordin	Keyboard
23	22	Harmonca	Keyboard
24	23	Bandonn	Keyboard
25	8	Celesta	Chromatic Percussion
26	9	Glcknspl	Chromatic Percussion
27	10	MusicBox	Chromatic Percussion
28	11	Vibes	Chromatic Percussion
29	12	Marimba	Chromatic Percussion
30	13	Xyloph	Chromatic Percussion
31	14	TurBell	Chromatic Percussion
32	15	Dulcimer	Guitar
33	24	Nylon	Guitar
34	25	Steel	Guitar
35	26	JazzGTR	Guitar
36	27	Clean	Guitar
37	28	Muted	Guitar
38	29	OD GTR	Guitar
39	30	Dist GTR	Guitar
40	31	GTR Harm	Guitar
41	32	Acoustic	Bass
42	33	Fingered	Bass
43	34	Picked	Bass
44	35	Fretless	Bass
45	36	Slap 1	Bass
46	37	Slap 2	Bass
47	38	SynBass1	Bass
48	39	SynBass2	Bass
49	40	Violin	Orchestra
50	41	Viola	Orchestra
51	42	Cello	Orchestra
52	43	STR BS	Orchestra

OVERTURE 2 DIGITAL PIANO

53	44	Trem STR	Orchestra
54	45	Pizz	Orchestra
55	46	Harp	Orchestra
56	47	Timpani	Orchestra
57	48	Strings	Orchestra
58	49	SlwStrng	Orchestra
59	50	SynStrg1	Orchestra
60	51	SynStrg2	Orchestra
61	52	Choir	Orchestra
62	53	Voices	Orchestra
63	54	SynVox 1	Orchestra
64	55	Orch Hit	Orchestra
65	56	Trumpet	Brass
66	57	Trombone	Brass
67	58	Tuba	Brass
68	59	MuteTrpt	Brass
69	60	Fr Horns	Brass
70	61	Brass	Brass
71	62	SynBrss1	Brass
72	63	SynBrss2	Brass
73	64	Soprano	Wind
74	65	Alto	Wind
75	66	Tenor	Wind
76	67	Baritone	Wind
77	68	Oboe	Wind
78	69	Eng Horn	Wind
79	70	Bassoon	Wind
80	71	Clarinet	Wind
81	72	Piccolo	Wind
82	73	Flute	Wind
83	74	Recorder	Wind
84	75	PanFlute	Wind
85	76	Bottle	Wind
86	77	Shaku	Wind
87	78	Whistle	Wind



88	79	Ocarina	Wind
89	80	Sqr Wave	Synthetic
90	81	Saw Wave	Synthetic
91	82	SynCalli	Synthetic
92	83	Chiffer	Synthetic
93	84	Charang	Synthetic
94	85	SynVox 2	Synthetic
95	86	Saw 5th	Synthetic
96	87	Bss&Lead	Synthetic
97	88	New Age	Synthetic
98	89	Warmpad	Synthetic
99	90	Polysyn	Synthetic
100	91	SpaceVox	Synthetic
101	92	BowGlass	Synthetic
102	93	MetalPad	Synthetic
103	94	HaloPad	Synthetic
104	95	SweepPad	Synthetic
105	96	RainPad	Synthetic
106	97	SoundTrk	Synthetic
107	98	Crystal	Synthetic
108	99	Atmosph	Synthetic
109	100	BriteSyn	Synthetic
110	101	Globins	Synthetic
111	102	Echos	Synthetic
112	103	Sci Fi	Synthetic
113	104	Sitar	Ethnic
114	105	Banjo	Ethnic
115	106	Shamison	Ethnic
116	107	Koto	Ethnic
117	108	Kalimba	Ethnic
118	109	Bagpip	Ethnic
119	110	Fiddle	Ethnic
120	111	Shenai	Ethnic
121	112	TinkBell	Percussion
122	113	Agogo	Percussion

OVERTURE 2 DIGITAL PIANO

123	114	SteelDrm	Percussion
124	115	WoodBlk	Percussion
125	116	Taiko	Synthetic
126	117	Mel Tom	Sound Effect
127	118	Syn Drum	Sound Effect
128	119	Rev Cym	Sound Effect
129	120	Fretnois	Sound Effect
130	121	Breath	Sound Effect
131	122	Seashore	Sound Effect
132	123	Birds	Sound Effect
133	124	Telephon	Sound Effect
134	125	Helicopt	Sound Effect
135	126	Applause	Sound Effect
136	127	Gunshot	Sound Effect
137	0**	Standard	GM Kit
138	8**	Room	GM Kit
139	16**	Power	GM Kit
140	24**	Electro	GM Kit
141	32**	Hip Hop	GM Kit
142	40**	Jazz	GM Kit
143	48**	Brush	GM Kit
144	56**	Latin	GM Kit
145	64**	Orch	GM Kit
146	72**	Techno	GM Kit
147	80**	SFX	GM Kit

*- This sound must have a Bank Select message to play this sound through MIDI.

**- These can only be played on MIDI channel 10 and use the specific MIDI program change numbers for the kit.



Drum Sounds

	Standard_Kit	Room_Kit	Power Kit	Electro Kit
Program Change	0	8	16	24
27 – Eb0	Click	Click	Click	Click
28 – E	Brush Tap	Brush Tap	Brush Tap	Brush Tap
29 – F0	Scratch Push	Scratch Push	Scratch Push	Scratch Push
30 – F#0	Scratch Pull	Scratch Pull	Scratch Pull	Scratch Pull
31 – G0	Stick	Stick	Stick	Stick
32 – G#0	Soft Snare	Soft Snare	Soft Snare	Soft Snare
33 – A0	Bass Drum 1	Bass Drum 1	Bass Drum 1	Bass Drum 1
34 – A#0	Bass Drum 2	Bass Drum 2	Bass Drum 2	Bass Drum 2
35 – B0	Vintage Bass Drum	Vintage Bass Drum	Vintage Bass Drum	Vintage Bass Drum
36 – C1	Studio Bass Drum	Funk	Maple Bass Drum	808 Kick
38 – D1	Funk Snare	Shallow Brass	Maple Snare	808 Snare
39 – D#1	Electro Clap	Electro Clap	Electro Clap	808 Clap
40 – E1	Funk Snare Rim Shot	Shallow Brass RS	Maple Snare RS	808 Rim
41 – F1	Studio Tom Low	Funk Tome Low	Maple Tom Low	Lo Electro Tom
42 – F#1	Hi Hat Closed	Hi Hat Closed	Hi Hat Closed	808 Hat Closed
43 – G1	Studio Tom Mid	Funk Tom Mid	Maple Tom Mid	Mid Electro Tom
44 – G#1	Hi Hat Foot	Hi Hat Foot	Hi Hat Foot	808 Foot
45 – A1	Studio Tom Mid	Funk Tom Mid	Maple Tom Mid	Mid Electro Tom
46 – A#1	Hi Hat Open	Hi Hat Open	Hi Hat Open	808 Hat Open
47 – B1	Studio Tom Hi	Funk Tom Hi	Maple Tom Hi	Hi Electro Tom
48 – C2	Studio Tom Hi	Funk Tom Hi	Maple Tom Hi	Hi Electro Tom
49 – C#2	Crash Cymbal	Crash Cymbal	Crash Cymbal	808 Crash
50 – D2	Studio Tom Hi	Funk Tom Hi	Maple Tom Hi	Hi Electro Tom
51 – D#2	Ride Bow	Ride Bow	Ride Bow	Techno Ride
52 – E2	China Cymbal	China Cymbal	China Cymbal	China Cymbal
53 – F2	Ride Bell	Ride Bell	Ride Bell	Ride Bell
54 – F#2	Tambourine	Tambourine	Tambourine	Tambourine
55 – G2	Splash Cymbal	Splash Cymbal	Splash Cymbal	Splash Cymbal
56 – G#2	Cowbell	Cowbell	Cowbell	Cowbell
57 – A2	Crash Cymbal	Crash Cymbal	Crash Cymbal	Crash Cymbal
58 – A#2	Vibraslap	Vibraslap	Vibraslap	Vibraslap
59 – B2	Ride Bow	Ride Bow	Ride Bow	Ride Bow
60 – C3	Small Bongo	Small Bongo	Small Bongo	Small Bongo
61 – C#3	Large Bongo	Large Bongo	Large Bongo	Large Bongo
62 – D3	Conga Mute	Conga Mute	Conga Mute	Conga Mute

OVERTURE 2 DIGITAL PIANO

63 – D#3	Conga	Conga	Conga	Conga
64 – E3	Tumba	Tumba	Tumba	Tumba
65 – F3	Hi Timbale	Hi Timbale	Hi Timbale	Hi Timbale
66 – F#3	Low Timbale	Low Timbale	Low Timbale	Low Timbale
67 – G3	Small Agogo	Small Agogo	Small Agogo	Small Agogo
68 – G#3	Large Agogo	Large Agogo	Large Agogo	Large Agogo
69 – A3	Cabasa	Cabasa	Cabasa	Cabasa
70 – A#3	Marcas	Marcas	Marcas	Marcas
71 – B3	Whistle	Whistle	Whistle	Whistle
72 – C4	Long Whistle	Long Whistle	Long Whistle	Long Whistle
73 – C#4	Short Guiro	Short Guiro	Short Guiro	Short Guiro
74 – D4	Long Guiro	Long Guiro	Long Guiro	Long Guiro
75 – D#4	Clave	Clave	Clave	Clave
76 – E4	Hi Woodblock	Hi Woodblock	Hi Woodblock	Hi Woodblock
77 – F4	Low Wodblock	Low Wodblock	Low Wodblock	Low Wodblock
78 – F#4	Mute Quica	Mute Quica	Mute Quica	Mute Quica
79 – G4	Quica	Quica	Quica	Quica
80 – G#4	Mute Triangle	Mute Triangle	Mute Triangle	Mute Triangle
81 – A4	Open Triangle	Open Triangle	Open Triangle	Open Triangle
82 – A#4	Cabasa	Cabasa	Cabasa	Cabasa
83 – B4	Shaker	Shaker	Shaker	Shaker
84 – C5	BellTree	BellTree	BellTree	BellTree
85 – C#5	Castanets	Castanets	Castanets	Castanets
86 – D5	Mute Surdo	Mute Surdo	Mute Surdo	Mute Surdo
87 – D#5	Open Surdo	Open Surdo	Open Surdo	Open Surdo

	Hip Hop_Kit	Jazz_Kit	Brush Kit	Latin Perc Kit
Program Change	32	40	48	56
27 – Eb0	Click	Click	Click	Click
28 – E0	Brush Tap	Brush Tap	Brush Tap	Brush Tap
29 – F0	Scratch Push	Scratch Push	Scratch Push	Scratch Push
30 – F#0	Scratch Pull	Scratch Pull	Scratch Pull	Scratch Pull
31 – G0	Stick	Stick	Stick	Stick
32 – G#0	Soft Snare	Soft Snare	Soft Snare	Soft Snare
33 – A0	Bass drum 1	Bass drum 1	Bass drum 1	Bass drum 1
34 – A30	Bass drum 2	Bass drum 2	Bass drum 2	Bass drum 2



35 – B0	808 Kick	Jazz Bass Drum	Vintage Bass Drum	Surdo
36 – C1	Hip Hop Bass Drum	Jazz Bass Drum	Jazz Bass Drum	Surdo
37 – C#1	808 Snare	Shallow Wood CS	Deep Brass CS	Timbale
38 – D1	Hip Hop Snare	Shallow Wood Snare	Brush Snare	Timbale
39 – D#1	808 Clap	Shallow Wood Snare	Deep Brass Snare	Timbale RS
40 – E1	Hip Hop Snare 2	Shallow Wood RS	Brush Snare RS	Low Maple Tom
41 – F1	Low E Tom	Low Jazz Tom	Low Brush Tom	Shaker
42 – F#1	Hip Hop Hi Hat Closed	Hi Hat Closed	Hi Hat Closed	Tumba
43 – G1	Mid E Tom	Mid Jazz Tom	Mid Brush Tom	Clave
44 – G#1	Hip Hop Foot	Hi Hat Foot	Hi Hat Foot	Bongo
45 – A1	Mid E Tom	Mid Jazz Tom	Mid Brush Tom	Cabasa
46 – A#1	Hip Hop Hi Hat Open	Hi Hat Open	Hi Hat Open	
47 – B1	Hi E Tom	Hi Jazz Tom	Hi Brush Tom	Conga
48 – C2	Hi E Tom	Hi Jazz Tom	Hi Brush Tom	Hi Maple Tom
49 – C#2	808 Cymbal	Crash Cymbal	Crash Cymbal	Ride Bow
50 – D2	Hi E Tom	Hi Jazz Tom	Hi Brush Tom	Hi Maple Tom
51 – D#2	Techno Ride	Ride Bow	Ride Bow	Ride Bow
52 – E2	China Cymbal	China Cymbal	China Cymbal	China Cymbal
53 – F2	Ride Bell	Ride Bell	Ride Bell	Ride Bell
54 – F32	Tambourine	Tambourine	Tambourine	Tambourine
55 – G2	Splash Cymbal	Splash Cymbal	Splash Cymbal	Splash Cymbal
56 – G#2	808 Cowbell	Cowbell	Cowbell	Cowbell
57 – A2	Techno Crash	Crash Cymbal	Crash Cymbal	Crash Cymbal
58 – A#2	Vibraslap	Vibraslap	Vibraslap	Vibraslap
59 – B2	Ride Bow	Ride Bow	Ride Bow	Ride Bow
60 – C3	Small Bongo	Small Bongo	Small Bongo	Small Bongo
61 – C#3	Large Bongo	Large Bongo	Large Bongo	Large Bongo
62 – D3	Conga Mute	Conga Mute	Conga Mute	Conga Mute
63 – D#3	Conga	Conga	Conga	Conga
64 – E3	Tumba	Tumba	Tumba	Tumba
65 – F3	Hi Timbale	Hi Timbale	Hi Timbale	Hi Timbale
66 – F#3	Low Timbale	Low Timbale	Low Timbale	Low Timbale
67 – G3	Small Agogo	Small Agogo	Small Agogo	Small Agogo
68 – G#3	Large Agogo	Large Agogo	Large Agogo	Large Agogo
69 – A3	Cabasa	Cabasa	Cabasa	Cabasa
70 – A#3	Marcas	Marcas	Marcas	Marcas
71 – B3	Whistle	Whistle	Whistle	Whistle
72 – C4	Long Whistle	Long Whistle	Long Whistle	Long Whistle
73 – C#4	Short Guiro	Short Guiro	Short Guiro	Short Guiro

OVERTURE 2 DIGITAL PIANO

74 – D4	Long Guiro	Long Guiro	Long Guiro	Long Guiro
75 – D#4	Clave	Clave	Clave	Clave
76 – E4	Hi Woodblock	Hi Woodblock	Hi Woodblock	Hi Woodblock
77 – F4	Low Woodblock	Low Woodblock	Low Woodblock	Low Woodblock
78 – F#4	Mute Quica	Mute Quica	Mute Quica	Mute Quica
79 – G4	Quica	Quica	Quica	Quica
80 – G#4	Mute Triangle	Mute Triangle	Mute Triangle	Mute Triangle
81 – A4	Open Triangle	Open Triangle	Open Triangle	Open Triangle
82 – A#4	Cabasa	Cabasa	Cabasa	Cabasa
83 – B4	Shaker	Shaker	Shaker	Shaker
84 – C5	BellTree	BellTree	BellTree	BellTree
85 – C#5	Castanets	Castanets	Castanets	Castanets
86 – D5	Mute Surdo	Mute Surdo	Mute Surdo	Mute Surdo
87 – D#5	Open Surdo	Open Surdo	Open Surdo	Open Surdo

	Orchestra_Kit	Techno_Kit	Sound Effects Kit
Program Change	64	72	80
27 – Eb0	Click	Click	Click
28 – E0	Brush Tap	Brush Tap	Brush Tap
29 – F0	Scratch Push	Scratch Push	Scratch Push
30 – F#0	Scratch Pull	Scratch Pull	Scratch Pull
31 – G0	Stick	Stick	Stick
32 G#0	Soft Snare	Soft Snare	Soft Snare
33 – A0	Bass drum 1	Bass drum 1	Bass drum 1
34 – A#0	Bass drum 2	Bass drum 2	Bass drum 2
35 – B0	Orchestra Bass Drum	Electro Kick	No Sound
36 – C1	Orchestra Bass Drum	Techno Kick	No Sound
37 – C#1	Shallow Wood Snare CS	Hip Hop Snare	Seashore
38 – D1	Shallow Wood Snare	Techno Snare	Birds
39 – D#1	Shallow Wood Snare	Techno Clap	Telephone
40 – E1	Shallow Wood Snare RS	Techno Snare	Helicopter
41 – F1	Timpani	Simmons Lo Tom	Applause
42 – F#1	Hi Hat Closed	Techno Hi Hat Closed	Gun Shot
43 – G1	Timpani	Simmons Lo Tom	No Sound
44 – G#1	Hi Hat Foot	Techno Hi Hat Foot	No Sound
45 – A1	Vintage Tom	Simmons Mid Tom	No Sound
46 – A#1	Hi Hat Open	Techno Hi Hat Open	No Sound



47 – B1	Vintage Tom	Simmons Hi Tom	No Sound
48 – C2	Vintage Tom	Simmons Hi Tom	No Sound
49 – C#2	Crash Cymbal	Techno Crash	No Sound
50 – D2	Vintage Tom	Simmons Tom Hi	No Sound
51 – D#2	Ride Bow	Ride Bow	No Sound
52 – E2	China Cymbal	Simmons Cymbal	No Sound
53 – F2	Ride Bell	Techno Crash	No Sound
54 – F#2	Tambourine	Tambourine	No Sound
55 – G2	Splash Cymbal	Splash Cymbal	No Sound
56 – G#2	Cowbell	Cowbell	No Sound
57 – A2	Crash Cymbal	Crash Cymbal	Crash Cymbal
58 – A#2	Vibraslap	Vibraslap	Vibraslap
59 – B2	Ride Bow	Ride Bow	Ride Bow
60 – C3	Small Bongo	Small Bongo	Small Bongo
61 – C#3	Large Bongo	Large Bongo	Large Bongo
62 – D3	Conga Mute	Conga Mute	Conga Mute
63 – D#3	Conga	Conga	Conga
64 – E3	Tumba	Tumba	Tumba
65 – F3	Hi Timbale	Hi Timbale	Hi Timbale
66 – F#3	Low Timbale	Low Timbale	Low Timbale
67 – G3	Small Agogo	Small Agogo	Small Agogo
68 – G#3	Large Agogo	Large Agogo	Large Agogo
69 – A3	Cabasa	Cabasa	Cabasa
70 – A#3	Maracas	Maracas	Maracas
71 – B3	Whistle	Whistle	Whistle
72 – C4	Long Whistle	Long Whistle	Long Whistle
73 – C34	Short Guiro	Short Guiro	Short Guiro
74 – D4	Long Guiro	Long Guiro	Long Guiro
75 – D#4	Clave	Clave	Clave
76 – E4	Hi Woodblock	Hi Woodblock	Hi Woodblock
77 – F4	Low Woodblock	Low Woodblock	Low Woodblock
78 – F#4	Mute Quica	Mute Quica	Mute Quica
79 – G4	Quica	Quica	Quica
80 – G#4	Mute Triangle	Mute Triangle	Mute Triangle
81 – A4	Open Triangle	Open Triangle	Open Triangle
82 – A#4	Cabasa	Cabasa	Cabasa
83 – B4	Shaker	Shaker	Shaker
84 – C5	BellTree	BellTree	BellTree
85 – C#5	Castanets	Castanets	Castanets
86 – D5	Mute Surdo	Mute Surdo	Mute Surdo
87 – D#5	Open Surdo	Open Surdo	Open Surdo

OVERTURE 2 DIGITAL PIANO

Demo Songs for the Voices

Each voice on the 18 Direct Access buttons has a separate demo song to profile the sound.

Button	Demo	Display Name
Piano	1	Fantasy
Electric Piano	2	EP Blues
Organ	3	Jazzy
Keys 1	4	Nylon
Keys 2	5	Synth
Bass	6	A Bass
Piano	7	Cabriole
Electric Piano	8	EP Funk
Organ	9	Rock Org
Keys 1	10	Vibey
Keys 2	11	Strings
Bass	12	E Bass
Piano	13	Lush Pno
Electric Piano	14	EP Synth
Organ	15	Fortress
Keys 1	16	JS Bach
Keys 2	17	FunkyClv
Bass	18	Syn Bass



TUTOR SONGS

Difficulty	Order	Display Name	File Name
Hard	1	Rachmnv	Rachmoninov - Prelude in C# Minor
	2	Chopin 1	Chopin - Fantasy Impromptu
	3	Bach 1	Bach - C Major Prelude
	4	Debussy1	Debussy – Clair de Lune
	5	Bach 2	Bach - Italian Concerto (Harpsic)
	6	Liszt	Liszt - Liebestraume
	7	Bach 3	Bach - C# Major Prelude
	8	Beethvn1	Beethoven - Moonlight
	9	Debussy2	Debussy - Dr. Gradus
	10	Bach 4	Bach - Mighty Fortress (Organ)
	11	Bach 8	Bach- Jesu 1 BWV776
Medium	12	Beethvn2	Beethoven –Rondo a capriccio OP129 G-major
	13	Bach 5	Bach – Bourree
	14	Bach 6	Bach-Invention-08 F major
	15	Bach 7	Bach- Musette 1
Easy	16	Chopin 2	Chopin - Prelude E Minor 1
	17	Chopin 3	Chopin - Minuet Waltz
	18	Mozart	Mozart - Minuet in F
	19	Grnslves	Greensleeves
	20	Satie	Gymnopedie
	21	AvaMaria	Ava Maria.mid
	22	Pachelbl	Johann Pachelbel - Canon

OVERTURE 2 DIGITAL PIANO

TUTOR SONGS

Difficulty	Order	Display Name	File Name
Rock Blues	23	Blues 1	Blues 1
	24	Blues 2	Boogie1
	25	Blues 3	Boogie2
	26	Rock 1	Rock3
	27	Rock 2	Rock5
	28	Rock 3	Rock1
	29	Rock 4	Rock4
	30	Rock 5	Rock2
	31	Rock 6	Rock6
	32	Blues 4	Blues 2
Etudes	33	Etude 1	
	34	Etude 2	
	35	Etude 3	
	36	Etude 4	
	37	Etude 5	
	38	Etude 6	
	39	Etude 7	
	40	Etude 8	
	41	Etude 9	
	42	Etude 10	
	43	Etude 11	
	44	Etude 12	
	45	Etude 13	
	46	Etude 14	
	47	Etude 15	
	48	Etude 16	
	49	Etude 17	
	50	Etude 18	



MIDI IMPLEMENTATION CHART

Function	Transmitted	Recognized	Remarks
Basic Default Channel Changed	1-16 CH X	1-16 CH 1-16 CH	
Mode Default Messages Altered	Mode 3 X *****	Mode 3 X X	
Note Number: True Voice	0-127 *****	0-127 0-127	
Velocity Note ON Note OFF	O 9nH,v=1-127 O 8nH,v=0	O 9nH,v=1-127 O 9nH,v=0 or 8nh	
After Key's	X	X	
Pitch Bender	X	O	
Control Change 0, 32 1 6 7 10 11 64 66 67 80, 81 84 91, 93 98, 99 100, 101 121	X X X O X X O O O X X X X X O	O O O O O O O O O O O O (*2) O (*1) O	Function Modulation Data Entry Volume Pan Expresssion Sustain Sostenuto Soft Pedal DSP Type Portamento DSP Depth NRPN LSB, MSB RPN LSB, MSB Reset All Controllers
Program Change: True	O 0-127 0-127	O 0-127 0-127	
System Exclusive	X	O	
System :Song Position :Song Select Common :Tune	X X O	X X X	
Aux :Local ON/OFF :All Notes OFF Messages :Active Sense :Reset	O O X O	O O X O	

Mode1:OMNI ON, POLY Mode2:OMNI ON,MONO O: Yes
Mode3:OMNI OFF, POLY Mode4:OMNI OFF,MONO X: NO

*1: Registered parameter number:
#0: Pitch sensivity
#1: Fine tuning in cents
#2: Coarse tuning in half-tones

*2: NRPN 1220h select IFX type
0: off
1: slow rotary
2: fast rotary
3: auto_pan
4: auto_tremelo

NRPN 1230h Enable IFX for current track
NRPN 1237h set global reverb send level if IFX have been enable on this track
NRPN 1238h set global chorus send level if IFX have been enable on this track



OVERTURE 2 DIGITAL PIANO

WARRANTY

Williams provides the following limited warranty, to the original purchaser: this piano is warranted to be free from electronic and/or structural defects in materials and workmanship for a period of one (1) year from the date of original purchase. If this Williams piano is defective, at its option during the warranty period, subject to the terms of this limited warranty and upon proof of purchase, Williams will either repair or replace the listed piano with a same or similar model of equal age or newer. Any repairs or modifications must be completed by Williams and/or an authorized agent of Williams. The warranty obligations as set forth herein shall be performed free of charge with the exception of all delivery and shipping expenses. This limited warranty will not apply to this product in the case of misuse, abuse, neglect, alterations, normal wear and tear or other circumstances not directly attributed to electronic and/or structural defects in materials or workmanship. Without limiting the foregoing, this limited warranty will also be inapplicable to products that have not been maintained or replaced in accordance with the manufacturer's instruction, or to products from which the serial number has been removed or altered. If covered defects are found, contact your authorized Williams dealer with regard to the alleged defect within ten (10) days of discovery of the problem.

The foregoing repair or replacement obligation for defective products shall be the sole and exclusive remedy of this limited warranty. All warranties including, but not limited to, the express warranty and the implied warranties of merchantability and fitness for a particular purpose are limited to the one (1) year warranty period. Some states do not allow limitation on how long an implied warranty lasts, so the above limitation may not apply to you. There are no express warranties beyond those stated here. In the event that applicable law does not allow the limitation of the duration of the implied warranties to the warranty period, then the duration of the implied warranties shall be limited to as long as is provided by applicable law. No warranties apply after that period. Retailer and manufacturer shall not be liable for damages based upon inconvenience, loss of use of product, loss of time, interrupted operation or commercial loss or any other incidental or consequential damages including but not limited to lost profits, downtime, goodwill, damage to or replacement of equipment and/or property.

1 Year Parts & Labor Warranty

Register online at www.williamspianos.com





WILLIAMSPIANOS.COM